



AF-300 MICRO-SAVER II™

1/4 - 5 Horsepower

Instructions



General Information – AF-300 Micro-Saver II™ Drive Instructions

These instructions do not purport to cover all details or variations in equipment, nor to provide for every possible contingency to be met during installation, operation, and maintenance. Should further information be desired or should particular problems arise that are not covered sufficiently for the purchaser's purpose, the matter should be referred to GE Fuji Electric, Customer Service.

This document contains proprietary information of GE Fuji Electric and is furnished to its customers solely to assist that customer in the installation, testing, and/or maintenance of the equipment described. This document shall not be reproduced in whole or in part nor shall its contents be disclosed to any third party without the written approval of GE Fuji Electric.

NOTE: The terms "inverter", "controller", and "drive" are sometimes used interchangeably throughout the industry. We will use the term "Drive" in this document.

AF-300 Micro-Saver II™ and XSD™ are trademarks of General Electric Company. Energy Saver® is a registered trademark of General Electric Company.

The terms "AF-300 Micro-Saver II" and AF-300M\$II will be used interchangeably throughout this document.

WARNING: Always read the complete instructions prior to applying power or troubleshooting the equipment and follow all procedures step by step.

SHOCK HAZARD labels may be located on or inside the Drive to alert people that dangerous voltage may be present. (Refer to Section 1: Safety Precautions for Warnings and Cautions.)

Blank space has been intentionally left at the bottom of each page for the convenience of the user in documenting notes.

TABLE OF CONTENTS

<u>Section</u>	<u>Title</u>	<u>Page</u>
1.	SAFETY PRECAUTIONS	1-1
2.	DESCRIPTION, COMPONENT IDENTIFICATION, AND SPECIFICATIONS	2-1
	General Description	2-1
	Delivery Inspection Procedures	2-1
	Nameplate Data	2-1
	Drive Keypad Functions and Layout	2-2
	Drive Components	2-3
	Table 1: Standard Specifications	2-4
	Table 2: Drive Dimensions	2-7
	Table 3: Drive Ratings, Efficiencies and Watts Loss	2-7
3.	INSTALLATION GUIDELINES	3-1
	Installation Environment	3-1
	Installation Mounting Clearance	3-1
	Dimension Drawings	3-2
	Dimensions of Keypad Mounting Holes	3-4
4.	WIRING PROCEDURES	4-1
	Remove Terminal Top Cover	4-1
	Control Circuit Wiring	4-2
	Main Circuit Wiring	4-3
	Table 4: Drive Wire Size Recommendations	4-4
	and Circuit Protection Rating	
	Control/Circuit Terminal Block	4-5
	Drive Wiring Diagram	4-6
	Table 5: Terminal Identification/Function	4-7
	Drive Interface Details	4-9
5.	DRIVE OPERATION	5-1
	Keypad Panel Identification/Operation	5-1
	Function Code and Data Code Description/Selection	5-1
	Keypad and Display Operation Programming	5-2
	Stop Mode	5-3
	Run Mode	5-4
	Program Mode while stopped	5-5
	Program Mode while running	5-6
	Trip Mode	5-7
	Summary of Operating Modes	5-8
	Pre-Operation Inspection	5-9
	Table 6: Function Code List	5-10
6.	FUNCTION CODE DESCRIPTIONS (01 thru 79)	6-1
	(Settings and Diagrams)	
7.	MAINTENANCE AND INSPECTION	7-1
	Megger Test	7-1
	Periodic Parts Replacement	7-1
	Inspection Items	7-2
	Measurement Points and Meters	7-3

TABLE OF CONTENTS (continued)

<u>Section</u>	<u>Title</u>	<u>Page</u>
8.	TROUBLESHOOTING	8-1
	Table 8: Fault Condition Description and Operation	8-1
	(1) Overcurrent	8-2
	(2) Overvoltage	8-3
	(3) Undervoltage	8-4
	(4) Drive Overheat	8-5
	(5) External Alarm Input	8-5
	(6) Drive Overload	8-6
	(7) Memory Error, Keypad Communication, CPU Error	8-7
	(8) Drive Output Circuit Error	8-8
	(9) Motor will not run	8-9
	(10) Motor will run but speed will not change	8-10
	(11) Motor will stall during acceleration	8-11
	(12) Motor Heating Abnormal	8-12
9.	WARRANTY PARTS AND SERVICE	9-1
	Warranty Coverage	9-1
	Out-of-Warranty Procedure	9-1
	Motors	9-1
	In-Warranty Failure Check List	9-2
	(Data necessary for Warranty Administration)	
	AF-300MSII Spare Parts List	9-3
10.	CE MARK	10-1

Section 1

SAFETY PRECAUTIONS

DANGER, WARNING, CAUTION AND NOTES

The following format is used on the equipment or found in this manual. Read all labels and follow the directions whenever working on the equipment.

▲ DANGER WARNS ABOUT HAZARDS THAT WILL RESULT IN IMMEDIATE SERIOUS PERSONAL INJURY OR DEATH IF IGNORED.

▲ WARNING Denotes operating procedures and practices that may result in personal injury or loss of life if not correctly followed.

▲ CAUTION Denotes operating procedures and practices that, if not strictly observed, may result in damage to, or destruction of the equipment.

NOTE: Notes call attention to information that is especially significant in understanding and operating the equipment.

DANGER, WARNING, CAUTION AND NOTE PARAGRAPHS WITHIN THIS INSTRUCTION MANUAL

The above paragraphs list some general safety reminders and safety recommendations to be followed when operating or installing this equipment. These safety precautions will be repeated throughout this instruction book where applicable.

Due to CSA requirements, pertinent warnings are also provided in French and set off by ()

WARNINGS

▲ DANGER **MECHANICAL MOTION HAZARD:** Drive systems cause mechanical motion. It is the responsibility of the user to insure that any such motion does not result in an unsafe condition. Customer provided interlocks, and operating limits should not be bypassed or modified.

▲ WARNING **ELECTRICAL SHOCK AND BURN HAZARD:** When using instruments such as oscilloscopes to work on live equipment, the oscilloscope's chassis should be grounded and a differential amplifier input should be used. Care should be used in the selection of probes and leads and in the adjustment of the oscilloscope so that accurate readings may be made. See instrument manufacturer's instruction book for proper operation and adjustments to the instrument.

▲ WARNING **FIRE AND EXPLOSION HAZARD:** Fires or explosions might result from mounting Drives in hazardous areas such as locations where flammable or combustible vapors or dusts are present. Drives should be installed away from hazardous areas, even if used with motors suitable for use in these locations.

▲ WARNING **STRAIN HAZARD:** Improper lifting practices can cause serious or fatal injury. Lift only with adequate equipment and trained personnel.

▲ WARNING **ELECTRICAL SHOCK HAZARD:** All motor bases and equipment enclosure housings should be grounded in accordance with the National Electric Code or equivalent.

▲ WARNING (AVERTISSEMENT) **HAZARD OF ELECTRICAL SHOCK (RIS QUE DE CHOC ELECTRIQUE)**

- Separate motor overcurrent, overload, and overheating protection is required to be provided in accordance with the Canadian Electrical Code, Part 1.
- (Le moteur doit être muni d'une protection distincte contre les surintensités, la surcharge et la surchauffe conformément au Code Canadien de L'électricité, première partie.)

▲ WARNING The Drive leakage current to ground is higher than 3mA. Use grounding conductor as specified in Table 250-95 of National Electric Code, ANSI/NFPA 70-1993 or Table 31 CSA22.2, No. 14-M91.

▲ DANGER **HAZARD OF MOTOR OVERSPEED:**

ANY APPLICATIONS REQUIRING OPERATION ABOVE 120 HZ MUST BE APPROVED BY THE MOTOR MANUFACTURER.

Bias frequency setting is available when analog frequency setting method (i.e. the Function code "01" data is set at 1) is selected. At the stop condition, the reference frequency will be blinking on the LED display. If the Bias frequency is set at a certain level and the reference frequency is Zero, during the stop condition, the display will be blinking Zero. Thus, when a RUN command is given to the Drive, the motor will run at the Bias frequency setting (up to 400 Hz) even if the reference frequency is Zero.

With 400 Hz Drive output possible, the Drive will allow the motor to run up to 6 - 7 times its base speed. Never operate the motor above its top mechanical speed or a catastrophic failure may occur.

▲ WARNING Before disassembling, disconnect and lock out power from the Drive. Failure to disconnect power may result in death or serious injury. A bus charge Light "CRG" provides visual indication that bus voltage is present; verify the bus voltage level by measuring the voltage between power terminals P(+) and N(-) using an analog meter. Do not attempt to service the Drive until the charge indicator ("CRG" lamp) has extinguished and the bus voltage has discharged to zero volts.

▲ WARNING Replace all covers before applying power to the Drive. Failure to do so may result in death or serious injury.

CAUTIONS

CAUTION This product is suitable for use on a circuit capable of delivering not more than **1,000** (1HP or less) or **5,000** (2 HP or more) rms symmetrical amperes. AC input fuses to be customer supplied and may be branch circuit protection fused. The maximum allowance fuse ratings per TABLE 4.

CAUTION Do not connect power supply voltage that exceeds the standard specified voltage permissible. If excessive voltage is applied to the Drive, damage to the internal components will result.

CAUTION Do not connect power supply to the output terminals (U, V, W). Connect power supply only to the power terminals (L1, L2, L3).

CAUTION Do not connect power supply to the breaking resistor connection terminals (P (+), DB). Never short-circuit between P (+) – DB terminals, and do not connect any resistance with an ohm and/or wattage value less than standard application breaking resistor.

CAUTION Do not connect a power supply to the control circuit terminals (except 30A, B, C, maximum rating 250 volts, 0.3A ac/dc).

CAUTION For RUN and STOP, use the FWD-CM (forward) and REV-CM (reverse) terminals. Do not use a contactor (ON/OFF) installed on the line side of the Drive for RUN and STOP.

CAUTION Do not use a switch on the output side of the Drive for ON/OFF operation.

CAUTION Do not connect power factor correcting capacitors on the output side of the Drive.

CAUTION Do not operate the Drive without the ground wire connected. The motor chassis should be grounded to earth through a ground lead separate from all other equipment ground leads to prevent noise coupling. The grounding connector shall be sized in accordance

with the NEC or Canadian Electrical Code. The connection shall be made by a UL listed or CSA certified closed-loop terminal connector sized for the wire gauge involved. The connector is to be fixed using the crimp tool specified by the connector manufacturer.

CAUTION Do not perform a megger test between the Drive terminals or on the control circuit terminals.

CAUTION The Drives are an IGBT drive which develops an adjustable frequency via pulse width modulation. While this does not present a problem on 200-240 VAC applications, it may on 380-480 VAC applications. When using the Drives on 380-480 VAC, get the motor manufacturer's approval that his insulation system can withstand the voltage spikes (up to twice the dc bus voltage 2 x 621 VDC for a 480 VAC power source of the Drive, in conjunction with the long motor cable lengths). If the insulation system does not meet this limit, utilize a RLC filter.

CAUTION Because the ambient temperature greatly affects Drive life and reliability, do not install the Drive in any location that exceeds the allowable temperature. Leave the ventilation covers attached for temperatures of 40 degrees C or below, and remove the ventilation port side and top covers for temperatures of between 40 (104° F) and 50 (122° F) degrees C. **If the covers need to be removed, another type of enclosure may be required for safety purposes.**

CAUTION If the Drive's Fault Alarm is activated, consult the TROUBLESHOOTING section of this instruction book, and after correcting the problem, resume operation. Do not reset the alarm automatically by external sequence, etc.

CAUTION Be sure to remove the desiccant packet(s) when unpacking the Drive. (If not removed these packets may become lodged in the fan or air passages and cause the Drive to overheat.)

CAUTIONS (continued)

CAUTION AC induction motors require that they be sized based on the applications speed range and associated torque requirements for the motor-Drive system; this is to avoid excessive motor heating. Observe motor manufacturer's recommendations when operating any ac induction motor with the Drive. Also observe motor manufacturer's recommended voltage/torque boost at lower operating frequencies.

CAUTION The available power source connected to the Drive is not to exceed 500KVA. If the ac power source is greater than 500KVA and the Drive's rated (HP) is less than 10% of the power source's KVA; ac line reactors will have to be installed in L1, L2 & L3 power leads of the Drive.

CAUTION The Drive must be mounted on a building or enclosure wall that is constructed of heat resistant material. While the Drive is operating, the temperature of the Drive's cooling fins can rise to a temperature of 90°C (194°F).

CAUTION If the Drive protective function is activated, consult Section 8 "Troubleshooting", and after correcting the problem, resume operation. **Do not reset the alarm automatically by external sequence, etc.**

CAUTION Be sure to provide fuses, as specified on "Application of Wiring And Equipment" in Section 4, on line terminals of Drive. Provide power line disconnect or contactor as needed.

NOTES

NOTE:

- When terminal operation mode (Function code F_02 setting is 1) - RUN and STOP are being controlled by a maintained contact (e.g., selector switch, toggle switch, etc.) which is connected between the terminal CM and FWD or REV:
 - Closing/opening the maintained contact starts/stops the Drive.
- Function code F_02 setting can be changed only when connection between the terminals CM and FWD or REV is open. (i.e. STOP MODE). **Drive ships with shorting bar between terminals FWD-CM.**

- Total wiring between the Drive and the motor must not exceed the length shown below.

Function	200V Series					400V Series		
F_12 data	Hp	1/4	1/2	1	2	3	5	
F_12 = 0, 1, 2 or 3					538 ft.	754 ft.		
F_12 = 4 - 15		1076 ft.			213 ft.	1076 ft.		

- Error in current detection may increase when:
 - A specially designed motor is used.
 - A Drive's capacity is 2 Hp ratings or greater than the motor capacity.

UL/CSA Drive Caution Label

Use 60/70°C copper wire only. Use Class 1 wire only. Suitable for use on a circuit capable of delivering not more than 1,000 (1HP or less) or 5,000 (2 HP or more) rms symmetrical amperes.

WARNING: HAZARD OF ELECTRICAL SHOCK. DISCONNECT INCOMING POWER BEFORE WORKING ON THIS CONTROL.
 AVERTISSEMENT: RISQUE DE CHOC ELECTRIQUE COUPER L'ALIMENTATION AVANT LE DEPANNAGE DE CETTE COMMANDE.
 CAUTION: DANGEROUS VOLTAGE EXIST UNTIL CHARGE "CRG" LIGHT IS OFF.
 ATTENTION: PRESENCE DE TENSIONS DANGEREUSES TANT QUE LE VOYANT N'EST PAS ETEINT.
 WARNING: MORE THAN ONE LIVE CIRCUIT. SEE DIAGRAM.*
 AVERTISSEMENT: CET EQUIPEMENT RENFERME PLUSIEURS CIRCUITS SOUS TENSION. VOIR LE SCHEMA.
 SA523154-01

*See diagram on page 4-6.

Section 2 DESCRIPTION, COMPONENT IDENTIFICATION, and SPECIFICATION

The Drive is available in ratings of 1/4 to 3 HP 200-240 VAC single phase input, 1/4 to 5 HP 200-230 VAC three phase, and 1/2 to 5 HP 380-480 VAC three phase. The Drive incorporates advanced Pulse Width Modulated (PWM) "TORQUE VECTOR" control for high starting torque. The Drives are housed in either a NEMA 1 or NEMA 4 type enclosure and all Drives are furnished with a detachable cover to allow ease of accessing control and power wiring.

Drive operation and Function Code setting is performed from the "Keypad Panel" that features a Digital Display and 6 dual function keys. The 6 function keys are used for Drive programming and operation.

General data and specifications for each Drive are listed on the nameplate attached to the Drive.

Refer to TABLE 1, for complete Drive specification listing.

INSPECTION PROCEDURES UPON DELIVERY

Upon receipt of your Drive, inspect the equipment for the following items:

1. Check the nameplate to insure that the specifications correspond to those ordered, and to application requirements.
2. Inspect the unit for any damage that may have occurred during shipment.
 - If shipping damage is found or the wrong Drive is received, contact the Distributor from which the equipment was purchased.

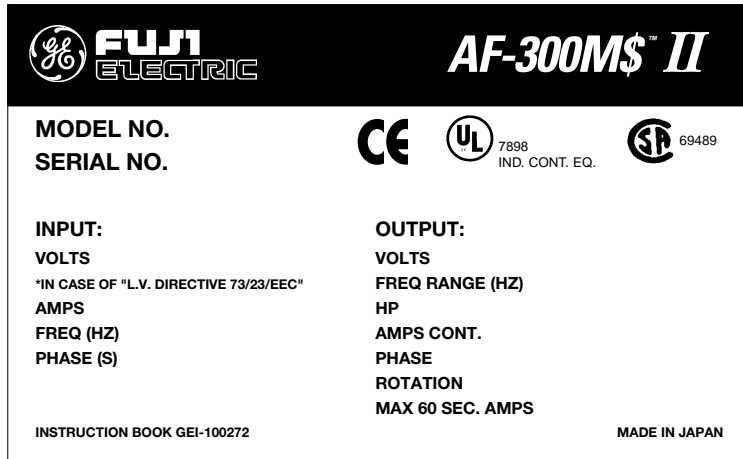

All models are UL Listed and CSA Approved. CE MARK applies to the 240 VAC single-phase and 480 VAC 3-phase

Figure 2-1. NAMEPLATE DATA IDENTIFICATION

(1) Keypad Part Names and Functions

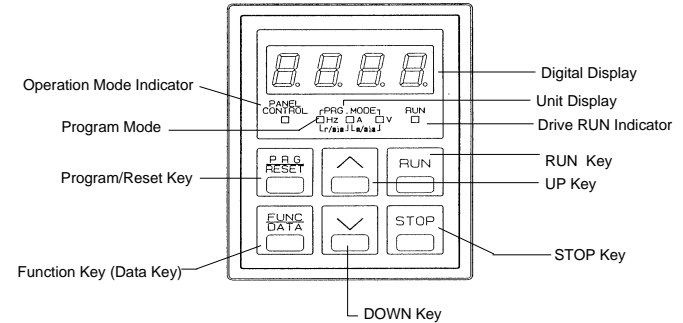

Digital Display (4 digits) - Displays the various Function Codes and data values during setting of the program. During operation, it displays the output frequency, current, voltage, etc. If a fault occurs the cause of the problem will be displayed as a code.

PROGRAM Key (Reset Key) - Normal mode or program setting mode select key. When any of the protection functions are activated; this key is used to reset the fault.

FUNCTION Key (Data Key) - During the normal mode, this key can be used to change the display unit while operation is either stopped or running. During the program mode, this key can be used to read and write the Function Codes and the data.

RUN Key - Key used for starting operation. The LED (green) lights up during operation.

This key does not function when terminal operation control is selected.

operation command input is accepted from the Keypad (RUN and STOP keys).

STOP Key - This key is used for stopping drive operation. When set as follows:

When function 2 is set to 1:

Operation command input by means of the external signal terminal (FWD, REV). STOP key on the keypad is active. If selection "1" is chosen, and the stop button is depressed while the drive is running, the drive will perform the normal stop sequence until the output frequency reaches zero at which point an "Er6" fault shall be indicated on the LED. To reset the

When function 2 is set to 2:

operation command input is accepted by means of the external signal terminal (FWD, REV). STOP key on the keypad is inactive.

UP / DOWN Keys - These keys increase or decrease the frequency reference. When units in program setting mode, they change the Function Code or data values.

drive you must remove the RUN command and press RESET.

When function 2 is set to 2:

operation command input is accepted by means of the external signal terminal (FWD, REV). STOP key on the keypad is inactive.

Unit Display - Unit information is displayed by the LED (red). All three LEDs flash to indicate that the unit is in the program mode.

Operation Mode Indicator - The LED (green) lights up when keypad panel operation is selected.

Drive RUN Indicator - The LED (green) lights up in the RUN mode.

(2) Controlling Method for Keypad Panel

When the power supply is activated, the keypad panel display will be as shown in the figure on the right (60.00 FLASHING).

If the **RUN** key is pressed, the Drive will start and accelerate up to 60 Hz according to the factory setting. Use the **STOP** key to stop operation.

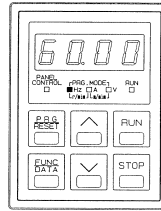

WARNING - RUN and STOP keys function only in Keypad operation mode. (Function Code F_02 setting is 0)

Drive Components

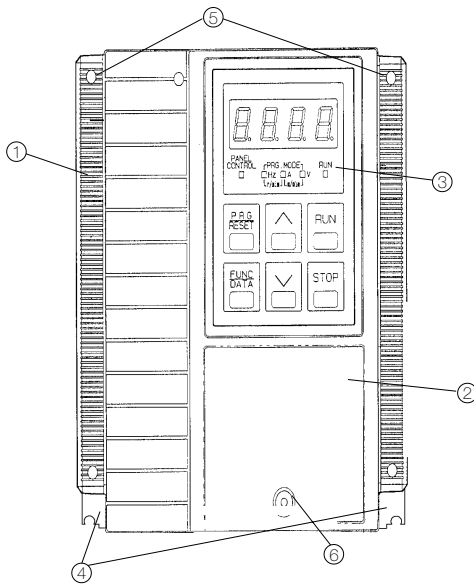

1. Unit Cover (Middle)
2. Unit Cover (Top)
3. Keypad Panel (Optional)
4. Heat Sink and Mounting Tabs
5. Mounting Screw Holes
6. Top Cover Screw

Figure 2-3. TYPICAL DRIVE COMPONENTS

NOTE: NEMA 1 unit does not include keypad. Keypad is sold separately.
Keypad type is 6KM\$2KP1 for NEMA 1 unit.

TABLE 1: Standard Specifications

ITEM	SPECIFICATION
Environmental Conditions	
Enclosure	NEMA 1 or NEMA 4
Installation Location: NEMA 1	Suitable for indoor mounting only, less than 1000 meters (3281 feet) elevation, not in contact with corrosive gas, oil mist, or dust.
NEMA 4	Suitable for use indoors or outdoors to protect the enclosed equipment against splashing water, seepage of water, falling or hose directed water and severe external condensation. Installation should be less than 1000 meters (3281 feet) elevation, not in contact with corrosive gas, or oil mist.
Stored Temperature	-20° to +65°C (-4° to +149°F)
Ambient Temperature	-10° to +50°C (+14° to +122°F) (remove ventilation covers if temperature is over (+40°C +104° F))
Humidity	20% to 95% relative humidity (non-condensing)
Vibration	0.6G or less
Cooling Method	1/4 to 1 HP – Convection 2 HP and greater – Forced air (Integral fan)
Output	
Rated Output Voltage	3-Phase, 3-Wire, 80-240 VAC or 160-480 VAC (Can not exceed power supply voltage)
Frequency Range	0 - 400 Hertz (0.2 to 15 Hz Start Frequency; 15 to 400 Hz Base Frequency) Above 120 Hz, contact the motor manufacturer for approval of application
Overload Current Rating	150% for 1 minute duration (inverse time characteristic) 200% for 0.5 seconds
Power Supply	
Rated Input AC Voltage	– 200 to 240 VAC 50/60 Hz, 1 phase (1/4 to 3 HP) – 200 to 230 VAC 50/60 Hz, 3 phase (1/4 to 5 HP) – 380 to 480 VAC 50/60 Hz, 3 phase (1/2 to 5 HP) Voltage: +10% to -15%; Voltage Unbalance: Within 3%; Frequency ±5%
Control System	Sinusoidal PWM "TORQUE VECTOR" Control
Control	
Frequency Setting Resolution	– Analog: 0.02 Hz step at Maximum frequency of 60 Hz – Digital Keypad: 0.01 Hz Maximum frequency up to 99.99 Hz; 0.1 Hz (100 Hz or more)
Accuracy (Stability)	Analog setting: ± 0.2% of Maximum frequency (59° to 95° F) Digital Keypad setting: ± 0.01% of Maximum frequency (14° to 122° F)

ITEM	SPECIFICATION
Control (continued)	
Voltage/Frequency Characteristics(V/F)	Voltage - 80-240 VAC or 160-480 VAC Frequency - 0.2 to 400 Hz
TorqueBoost	0: Automatic torque boost or 1 to 31.0 code settings (includes selection for variable torque load)
Acceleration/Deceleration Characteristics	0.01 to 3600 seconds (independent acceleration/deceleration) Alternative accel/decel time available as well as linear or 2 S-curves (selectable)
MotorSound	The pitch of the motor sound can be changed by selecting Carrier frequency (F_12: 0 to 15)
FrequencyMeterAdjustment	Scale calibration of externally connected analog meter or pulse frequency
DataProtection	Data lock is possible to ensure that the function codes are not changed
High/LowFrequencyLimiter	Output frequency upper and lower range limit 0 to 400 Hz; 1 Hz step settings
Bias	Magnitude of the zero offset can be set from 0 to $\pm 100\%$ of maximum frequency (1Hz steps)
Gain	Output frequency gain corresponding to the reference signal can be set from 0 to 250%
15StepPresetSpeed	15 programmable preset speeds selectable by 4 contact closures
MaintainedContactOperation	Maintained contact operation/stop command (2-wire operation)
TerminalFunctionChange	Multi-Use terminal changed via Function Code settings (X4 input; Y1 output)
Operation	
FrequencyReferenceSignal	Speed potentiometer: 0 to +10 VDC 4 to 20 mA [(0 to +5VDC) gain adjust 0-250%]
InputSignal(contactype)	Forward, reverse, multistep speed setting, alternate accel/decel time settings, coast-to-stop, external alarm, 3-wire control and reset
ExternalOutputSignals	One Dry Form "C" alarm output contact rated 250 VAC, 0.3 amp 1 – Open collector output rated 27 VDC, 50mA from external power – Drive Run – FDT – FAR – LV– TL – Auto restart mode after momentary power loss (IP)
FrequencyMeterOutputSignal	Pulse frequency (adjustment to 6 kHz maximum) Analog - 0 to +10 VDC (adjustment range of 6.5 to 10.3 VDC)

ITEM	SPECIFICATION
Operation (continued)	
ProtectiveFunctions:	<ul style="list-style-type: none"> – Stall prevention – Surge input – Drive overheating – External faults – CPU malfunction – Motor overload (electronic thermal) – Memory error – Undervoltage – Overcurrent – Overvoltage – Short circuit for output terminals – Communication error – Ground fault (at start) – Output wiring not connected (during auto tuning only)
Keypad	Digital Display - 4 digit LED
DriveOperation	Output frequency, output current, output voltage, motor speed, line speed (m/min), machine speed (r/min) can be displayed
DriveSetting	Function Code and Setting Data can be displayed
DataInitializing	Resets all Function Codes to initial factory settings
DriveFault	<ul style="list-style-type: none"> – OC1 - Acceleration overcurrent – OC2 - Deceleration overcurrent – OC3 - Constant speed overcurrent – LU (LV) - Undervoltage – OU1 - Overvoltage during acceleration – OU2 - Overvoltage during deceleration – OU3 - Overvoltage at constant speed – OH1 - Drive overheat – OH2 - External alarm input – OLU - Electronic Overload - Semiconductor Overload Protection – OL - Electronic Overload - 4 Pole Motor Overload Protection – Er1 - Setting error – Er2 - Communication error – Er3 - CPU error – Er4 - Optional circuit board communication error with Drive – Er5 - Optional Problem - when a link error etc. is detected – Er6 - Operating Proc. error – Er7 - Output wiring error
Charge"CRG"Lamp(LED)	Illuminates when DC Link capacitor voltage is present

Table 2: Drive Dimensions

240 Volt – Single Phase											
Model		HP	Weight		Height		Width		Depth		Dim. Figure
			LBS	KGS	Inches	MM	Inches	MM	Inches	MM	
NEMA 1		Const									
NEMA 4		TRQ									
6KMS221F25N1A1	6KMS221F25X4A1	1/4	2.7	1.2	6.22	158	4.29	109	3.15	80	1 and 4
6KMS221F50N1A1	6KMS221F50X4A1	1/2	3.8	1.7	6.22	158	5.67	144	4.29	109	2 and 6
6KMS221001N1A1	6KMS221001X4A1	1	4.0	1.8	6.22	158	5.67	144	4.29	109	2 and 6
6KMS221002N1A1	6KMS221002X4A1	2	6.2	2.8	6.22	158	8.03	204	5.28	134	3 and 8
6KMS221003N1A1	6KMS221003X4A1	3	6.4	2.9	6.22	158	8.03	204	5.28	134	3 and 8
230 Volt – Three Phase											
6KMS223F25N1A1	6KMS223F25X4A1	1/4	2.4	1.1	6.22	158	4.29	109	3.15	80	1 and 4
6KMS223F50N1A1	6KMS223F50X4A1	1/2	2.9	1.3	6.22	158	4.29	109	3.54	90	1 and 5
6KMS223001N1A1	6KMS223001X4A1	1	3.3	1.5	6.22	158	4.29	109	4.69	119	1 and 7
6KMS223002N1A1	6KMS223002X4A1	2	4.6	2.1	6.22	158	5.67	144	4.69	119	2 and 7
36KMS223003N1A1	6KMS223003X4A1	3	6.2	2.8	6.22	158	8.03	204	5.28	134	3 and 8
36KMS223005N1A1	6KMS223005X4A1	5	7.0	3.3	6.22	158	8.03	204	5.87	149	3 and 9
480 Volt – Three Phase											
6KMS243F50N1A1	6KMS243F50X4A1	1/2	4.2	1.9	6.22	158	5.67	144	4.29	109	2 and 6
6KMS243001N1A1	6KMS243001X4A1	1	4.2	1.9	6.22	158	5.67	144	4.29	109	2 and 6
6KMS243002N1A1	6KMS243002X4A1	2	6.2	2.8	6.22	158	8.03	204	5.28	134	3 and 8
6KMS243003N1A1	6KMS243003X4A1	3	6.2	2.8	6.22	158	8.03	204	5.28	134	3 and 8
6KMS243005N1A1	6KMS243005X4A1	5	7	3.3	6.22	158	8.03	204	5.87	149	3 and 9

Table 3: Drive Rating Efficiency and Watts Loss Table

240 Volt – Single Phase									
Model		HP	Output Current		Output Power	Efficiency Percentage		Watts Loss	
			Carrier Frequency			KW	Low	High	Low
NEMA 1		1/4	Low	High	0.19				
NEMA 4			Low	High					
6KMS221F25N1A1	6KMS221F25X4A1	1/2	3.0	2.5	0.37	88.1	83.2	50	75
6KMS221001N1A1	6KMS221001X4A1		1	5.0	4.0	0.75	90.4	88.8	80
6KMS221002N1A1	6KMS221002X4A1	2	8.0	7.0	1.50	92.9	91.5	115	140
6KMS221003N1A1	6KMS221003X4A1	3	11.0	10.0	2.20	93.6	92.4	150	180
230 Volt – Three Phase									
6KMS223F25N1A1	6KMS223F25X4A1	1/4	1.5	1.3	0.20	87.6	80.9	27	45
6KMS223F50N1A1	6KMS223F50X4A1	1/2	3.0	2.5	0.40	88.1	83.2	50	75
6KMS223001N1A1	6KMS223001X4A1	1	5.0	4.0	0.75	90.4	88.8	80	95
6KMS223002N1A1	6KMS223002X4A1	2	8.0	7.0	1.50	92.9	91.5	115	140
36KMS223003N1A1	6KMS223003X4A1	3	11.0	10.0	2.20	93.6	92.4	150	180
36KMS223005N1A1	6KMS223005X4A1	5	17.0	16.5	3.70	94.6	93.4	212	260
480 Volt – Three Phase									
6KMS243F50N1A1	6KMS243F50X4A1	1/2	1.6	1.4	0.37	86.0	79.9	60	93
6KMS243001N1A1	6KMS243001X4A1	1	2.5	2.1	0.75	90.4	86.9	80	113
6KMS243002N1A1	6KMS243002X4A1	2	3.7	3.7	1.50	93.2	88.1	110	203
6KMS243003N1A1	6KMS243003X4A1	3	5.5	5.3	2.20	94.4	89.4	130	260
6KMS243005N1A1	6KMS243005X4A1	5	9.0	8.7	3.70	94.9	91.0	200	366

NOTE: Carrier Frequency: High setting F_12 = 15
Low setting F_12 = 0

Section 3 INSTALLATION GUIDELINES

INSTALLATION ENVIRONMENT

Install the Drive in an indoor location that meets the following requirements:

- The ambient temperature is between -10° C and +50° C (+14° F to +122° F). Remove the ventilation covers when the temperature exceeds +40° C [+104° F].
- The relative humidity is between 20% and 95%. Avoid any location subject to condensation, freezing, or where the Drive would come in contact with water.
- Do not install in any location subject to direct sunlight, dust, corrosive gas, inflammable gas, or oil mist.
- Vibration should be less than 0.6G.
- The Drive should be installed at an elevation below 1000 meters (3281 feet). For installation above 1000 meters (3300 feet) the Drive will need to be derated 1% per 333 feet.

Example: 5 HP, 460 VAC, output current 9 amps.
Application altitude 3900 feet.

$$\% \text{ derate} = \left(\frac{3900 - 3300}{333} \right) \times 1\% = 1.8\%$$

$$(9 \text{ amps}) \times \left(\frac{100 - 1.8}{100} \right) = 8.84 \text{ amps derated output current.}$$

Motor derate may also be required, contact motor manufacturer.

CAUTION: Because the ambient temperature greatly affects Drive life and reliability, do not install the Drive in any location that exceeds the allowable temperatures.

INSTALLATION MOUNTING CLEARANCE

- Install at a sufficient distance from other equipment, walls, or wiring ducts as shown in Figure 3-1 (these clearances are required to allow the heat generated by the Drive to escape).
- Install the Drive perpendicular to the ground and with the lettering right side up. (If the Drive is installed upside-down or horizontally, heat build-up will occur.)
- Mounting screws or bolts should be of appropriate size for weight of Drive.
- See the appropriate figures on pages 3-2 and 3-3 for the location of mounting holes.
- After removing the knockouts in the wiring lead-in plate, install the rubber bushings supplied to prevent cable damage and to minimize dust entry.

CAUTION: The mounting wall for the Drive must be constructed of heat resistant material because during operation, the temperature of the Drive's cooling fins rises to approximately 90 degrees C (194° F).

NOTE: When installing two or more Drives in close proximity, allow sufficient space as shown in Figure 3-1 and install them in a horizontal row. If they must be installed in a vertical column, at least 19.7 inches (50cm) internal space must be provided between each one or a ventilation baffle should be provided to prevent the ambient temperature from rising.

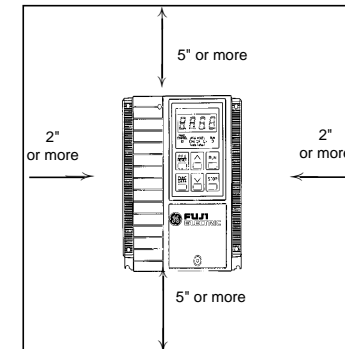

Figure 3-1. DRIVE MOUNTING CLEARANCE

Dimensions

NOTE: NEMA 1 unit does not have Keypad.
Shown with optional Keypad

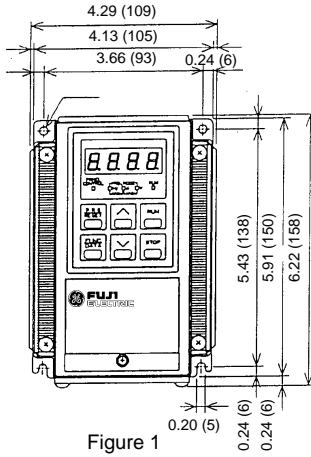

Figure 1

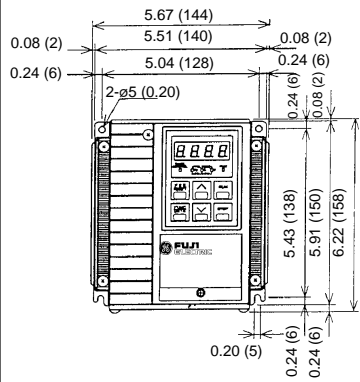

Figure 2

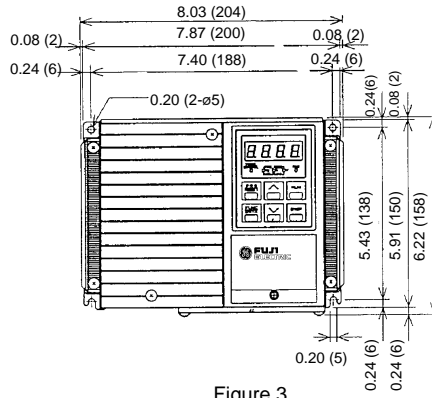

Figure 3

Note: Inches (MM)

Dimensions

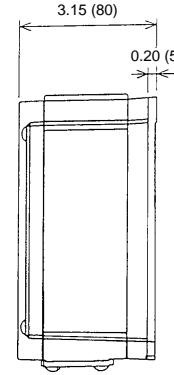

Figure 4

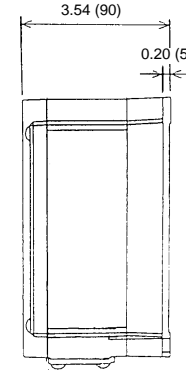

Figure 5

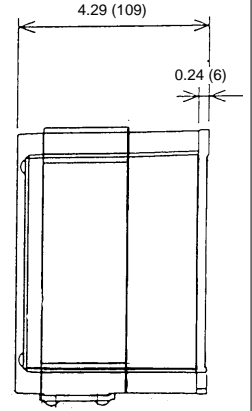

Figure 6

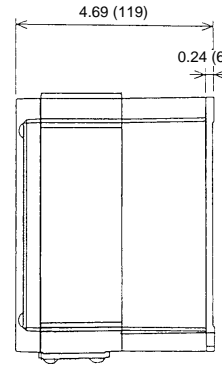

Figure 7

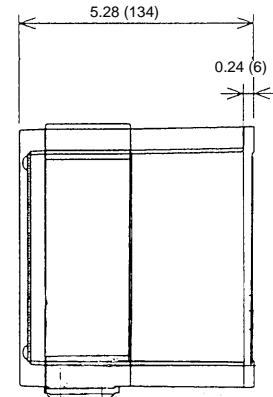

Figure 8

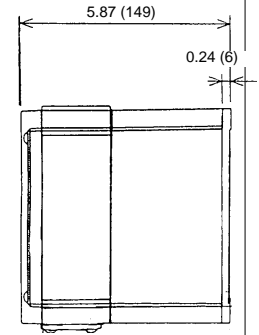
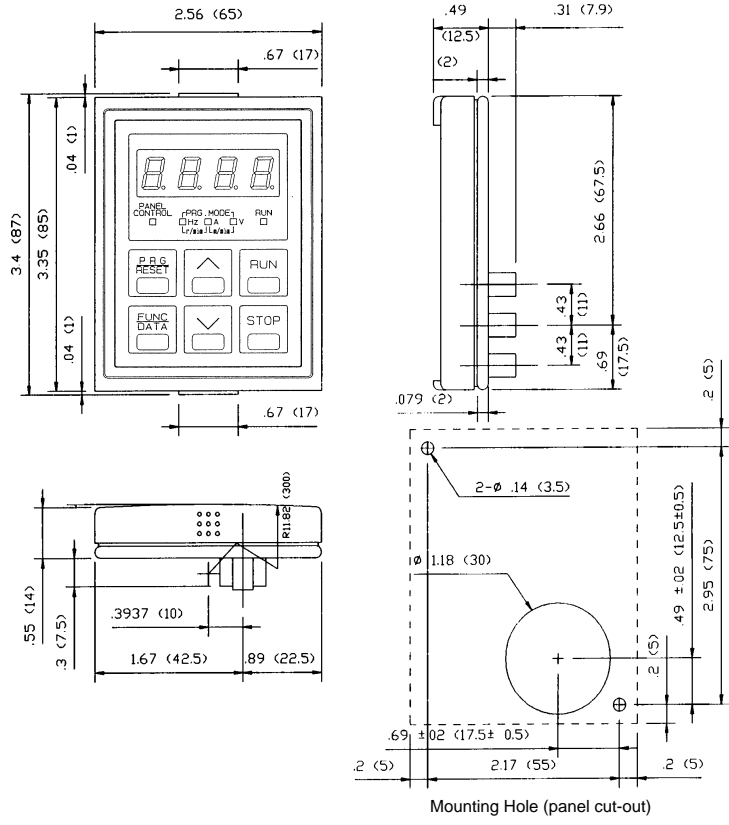

Figure 9

Note: Inches (MM)

Dimensions of Keypad and Keypad Mounting Holes



Keypad Part # 6KM\$2KP1 for NEMA 1 unit
6KM\$2KP4 for NEMA 4 unit

Inches (MM)

Section 4 WIRING PROCEDURES

Removing Top Cover

To access Main and Control Circuit Terminals remove the top cover as follows (see Figure 4-1):

1. Loosen the screw located at the bottom of the top cover.
2. Press upward on the bottom of the top cover (see arrows Figure 4-1 step 2) and lift off.
3. See Figure 4-1 for the location of the Main Circuit Terminal Block and the Control Circuit Terminal Block.

WARNING: Some printed circuit boards and Drive components may contain hazardous voltage levels. If LED light "CRG" on the Base Driver Board is illuminated, hazardous voltages are present in the Drive circuit boards. Remove and lock out power before you disconnect or reconnect wires, and before you remove or replace fuses and circuit boards. Do not attempt to service the Drive until the "CRG" indicator has extinguished and the bus voltage has discharged to zero volts.

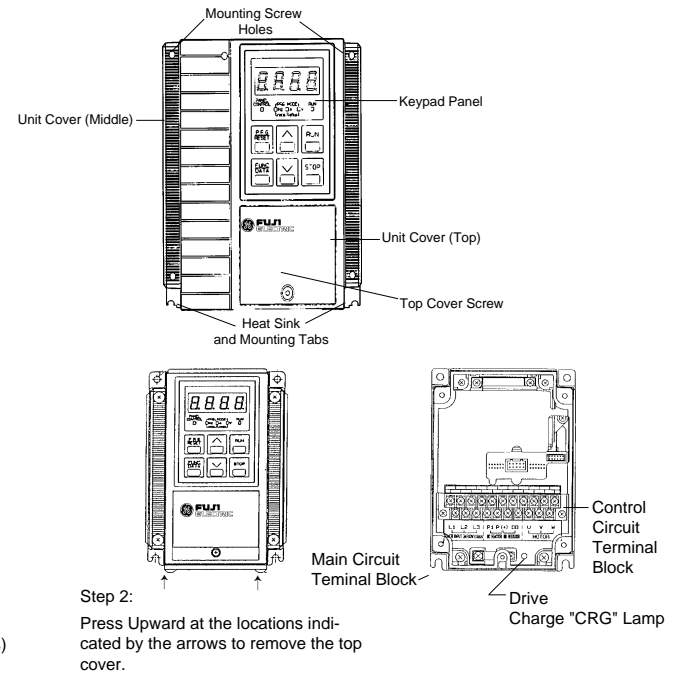

Figure 4-1. REMOVING THE TOP COVER

Control Circuit Wiring

Drive is wired at shipment for operation and frequency setting through the keypad panel (frequency is set at 60 Hz.)

- See Figure 4-2, and 4-4 for wiring connections.
- See TABLE 5 for description of all terminals.

Make wire connections as shown in Figure 4-4 through 4-6 for desired mode of external operation through Control Circuit Terminals.

CAUTION: The Control Circuit Terminal wiring should be kept as far away as possible from the main power wiring to prevent operational error due to noise interference. Never install both types of wiring in the same duct or conduit. (A separation distance of 4 inches [10 centimeters] or more is recommended.) If the control circuit wiring must cross the main power wiring, it should cross at a right angle.

CAUTION: Use shielded or twisted wire for the control circuit wiring (wiring should be as short as possible, i.e. 65 feet or less [20 meters.]) Connect outer covering of the shielded wires to the Drive ground terminal and leave the other end open, but taped with electrical insulating tape.

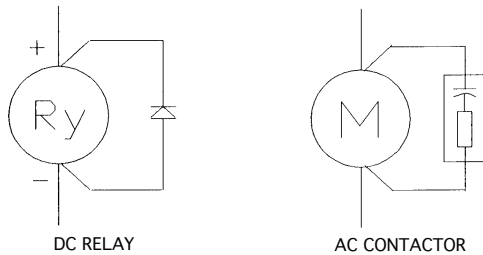

Figure 4-2. CONNECTION OF SURGE SUPPRESSION DEVICES

CAUTION: Install a suppressor in parallel with any relay or solenoid type coil as shown above, that may be close to the Drive to prevent noise from causing erratic Drive operation.

Main Circuit Wiring

CAUTION: Be sure that the power supply is never connected to the U, V, W terminals or the P (1), P (+), DB terminals.

1. Connect the ground terminal as shown in the appropriate view of Figure 4-3. (Do not operate without the unit being grounded.)
— **The ground wire must be minimum 14 AWG and short as possible**
2. Connect the power supply wires to the L1, L2, and L3 terminals of the Main Circuit Terminal Block as shown in the appropriate view of Figure 4-3. (See TABLE 5 for description of all terminals and TABLE 4 for recommended wire sizes.) Note that L1 and L2 terminals only, are available on single phase input models.
3. Connect the 3-phase motor wires to the U, V, and W terminals of the Main Circuit Terminal Block as shown in the appropriate view of Figure 4-3. (See TABLE 5 for description of all terminals and TABLE 4 for recommended wire sizes.)
4. Suitable for use on a circuit capable of delivering not more than **1000A** (1 HP or less) or **5000A** (2 HP or more) RMS symmetrical.
5. AC input fuses are to be customer supplied and may be branch circuit protection fuses. The maximum allowance fuse rating per TABLE 4.

NOTE: Motor will rotate counterclockwise when viewed from the shaft end when connected normally. If the motor rotates in reverse direction, interchange any two of the U, V, or W terminal connections.

240V – Single Phase 1/4 to 3 HP

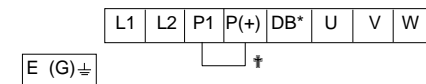

230 & 480V – Three Phase 1/4 to 5 HP

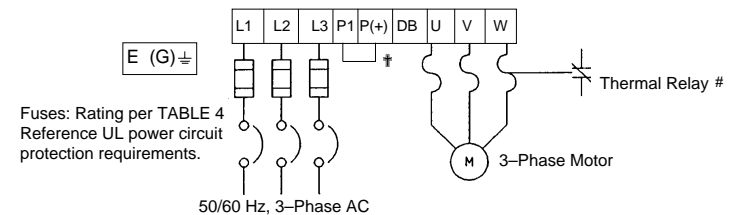

Fuses: Rating per TABLE 4 Reference UL power circuit protection requirements.

† Factory installed jumper (Remove when installing DC Reactor)

* The DB resistor connection is not available on models 6KM\$221F25X1A1, 6KM\$221F25A4A1, 6KM\$223F25X1A1, 6KM\$223F25A4A1.

Optional

Figure 4-3. MAIN CIRCUIT TERMINAL LAYOUT

Table 4:

**Wire Size Recommendations
& Circuit Protection Ratings**

240V – Single Phase and 230V Three Phase

Model		PH Input	HP Const TRQ	Output Current Carrier Frequency		Power Wire AWG	DB Resistor** Wire AWG	Incoming Power AC – Line Devices	
NEMA 1	NEMA 4			Low	High			Fuses*	Circuit Breaker
6KMS221F25N1A1	6KMS221F25X4A1	1	1/4	1.5	1.3	16	-	6	5
6KMS221F50N1A1	6KMS221F50X4A1	1	1/2	3	2.5	16	16	10	10
6KMS221001N1A1	6KMS221001X4A1	1	1	5	4	14	14	15	15
6KMS221002N1A1	6KMS221002X4A1	1	2	8	7	12	12	20	20
6KMS221003N1A1	6KMS221003X4A1	1	3	11	10	10	10	30	30
6KMS223F25N1A1	6KMS223F25X4A1	3	1/4	1.5	1.3	16	-	6	5
6KMS223F50N1A1	6KMS223F50X4A1	3	1/2	3	2.5	16	16	10	5
6KMS223001N1A1	6KMS223001X4A1	3	1	5	4	16	16	15	10
6KMS223002N1A1	6KMS223002X4A1	3	2	8	7	14	14	20	15
6KMS223003N1A1	6KMS223003X4A1	3	3	11	10	14	14	30	20
6KMS223005N1A1	6KMS223005X4A1	3	5	17	16.5	10	10	40	30

480V – Three Phase

Model		PH Input	HP Const TRQ	Output Current Carrier Frequency		Power Wire AWG	DB Resistor** Wire AWG	Incoming Power AC – Line Devices	
NEMA 1	NEMA 4			Low	High			Fuses*	Circuit Breaker
6KMS243F50N1A1	6KMS243F50X4A1	3	1/2	1.6	1.4	16	14	6	5
6KMS243001N1A1	6KMS243001X4A1	3	1	2.5	2.1	16	14	6	5
6KMS243002N1A1	6KMS243002X4A1	3	2	3.7	3.7	16	14	15	10
6KMS243003N1A1	6KMS243003X4A1	3	3	5.5	5.3	16	14	15	15
6KMS243005N1A1	6KMS243005X4A1	3	5	9.0	8.7	14	14	20	15

WARNING - Device ratings such as system coordination, short-circuit rating and type must be carefully reviewed by the user.

NOTE: Wire size from NEC table 310-16. Copper wire rated 60° C for 100 amps or less, 75° C for over 100 amps in 30° C ambient and 1.25 times Drive rated amps. These are minimum wire sizes; consult and conform to local and national codes.

***NOTE:** AC input fuses are required to validate the drive's UL and CSA approvals. The fuse should be Class J type such as Bussman, JKS or equivalent. Circuit breaker ratings are shown for reference, but UL and CSA approval can only be validated by the use of Class J fuses.

** Optional Item.

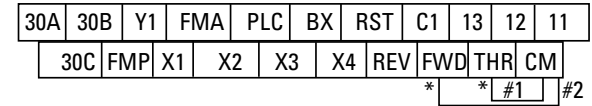

* Factory installed jumper

CONTROL CIRCUIT TERMINAL BLOCK LAYOUT

#1 CAUTION:
Remove jumper from between terminals THR and CM when a motor overload or a motor temperature switch is used. Wire the device thermal switch in series with the THR and CM terminals.

#2 NOTE:
FWD to CM jumper required for operation using keypad RUN-STOP.

Figure 4-4.

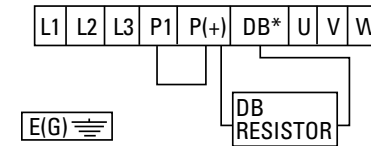

* Not available on 6KMS221F25X1A1, 6KMS221F25A4A1, 6KMS223F25X1A1, 6KMS223F25A4A1.

Figure 4-5. DYNAMIC BRAKING RESISTOR CONNECTIONS

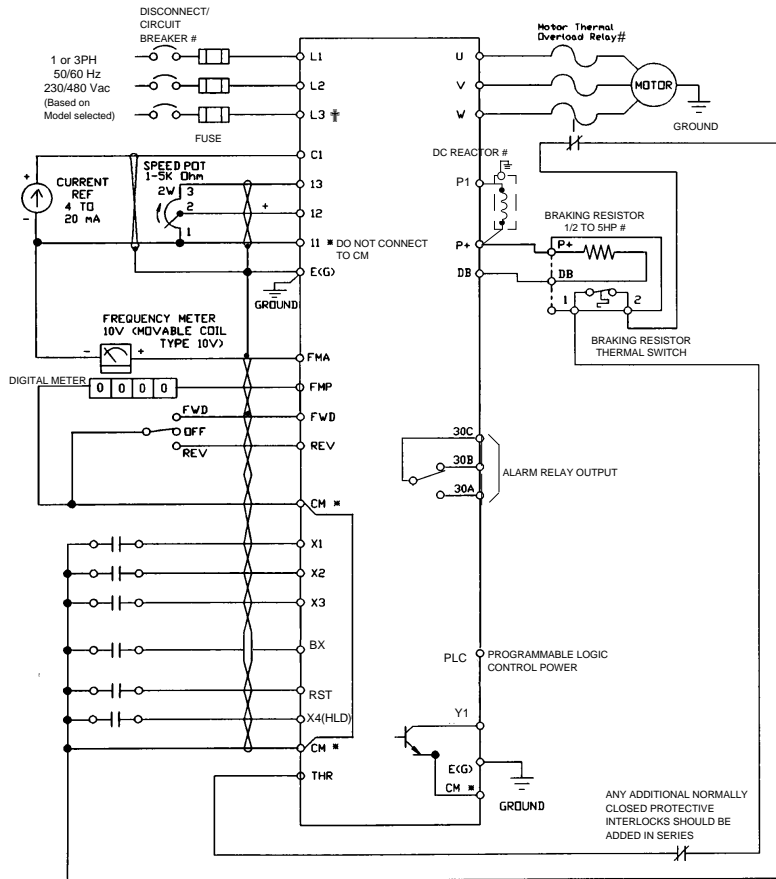

* Terminal 11 should not be connected to CM.
 † L3 not supplied on single phase units.
 # Optional

Figure 4-6. WIRING DIAGRAM

CAUTION:

1. The Control Circuit Terminal wiring should be kept as far as possible from the main circuit wiring to prevent operation error due to noise interference. Never install them in the same duct or conduit. A separation distance of 4 inches or more is recommended. If the control circuit wiring must cross the main circuit wiring, make sure it crosses at a right angle.
2. Use shielded wire for the control circuit wiring, which should be as short as possible (66 feet or less). Connect shield to the Drive ground terminal and leave the other end open but taped.
3. Install a surge protector in parallel with any magnetic contactors, solenoids, relays or timer coils which are close to the Drive.

TABLE 5: Terminal Identification/Function

Terminal Label	Terminal Name	Function
POWER TERMINAL BOARD		
L1, L2, L3	AC Supply Line Input Terminals	Connection for 200-230 VAC or 380-480 VAC, 3-phase, 50/60 Hz; L1 & L2 for single phase input, 200-240 VAC 50/60 Hz
U, V, W	Drive Output Terminals	Connection for 3-phase induction motor
P+, DB	External Braking Resistor Terminals	Connection for external braking resistor option for single phase and three phase drives (Only on 1/2 HP to 5 HP; not on 1/4 HP)
P1, P+	DC Reactor Terminals	Connection for external DC reactor for power factor improvement (Option). (Remove factory installed jumper)
CONTROL TERMINAL BOARD		
11	Frequency Setting & Analog Freq. Meter Common Terminal	Common connector for terminals 12, 13, C1 and FMA (Do not connect to CM terminal or electrical noise immunity may be lost).
12	Frequency Setting Voltage Input	When 0 to +10 VDC (0 to 5V*) is applied, the maximum frequency is reached at +10 VDC (5V*) and is proportional to output frequency down to 0 VDC. Input impedance is 22K ohm (*250% gain setting F_35)
13	Frequency Setting Voltage Output Term.	Regulated +10 VDC power supply for frequency setting potentiometer, 10mA or less (13 to terminal 11)
C1	Frequency Setting Current Input (+)	When the input signal is +4 to +20mA dc, the maximum frequency is reached at 20mA and is proportional to a minimum frequency setting at 4mA. Input impedance is 250 ohm, must be isolated source
CM	Control Circuit Common Terminal	Common terminal for control input commands, X1-X4, FWD, REV, BX, RST, THR, Y1 and FMP pulse output signal (Do not connect to terminal 11)
FWD	Forward Command Input Terminal	Forward command via FWD-CM (closed). Reverse command via REV-CM (closed). When FWD-CM and REV-CM are closed at the same time, the Drive will decelerate to stop
REV	Reverse Command Input Terminal	
BX	Motor Coast-To-Stop Command Input Terminal	Motor will coast-to-stop with BX-CM (closed). (For use when applying mechanical brake with Drive in operation.) Note: If BX-CM is opened with FWD or REV closed, the Drive will start the motor
RST	Fault Reset Input Terminal	After removal of fault condition, Faults are reset when a momentary contact closure is made between the RST-CM terminals for more than 0.1 seconds ⚠ DANGER <i>If there is an input to the FWD or REV terminals with F_02 = 1 OR 2 and F_14 = 4 or 5 the Drive will suddenly restart.</i>

TABLE 5: Terminal Identification/Function (continued)

Terminal Label	Terminal Name	Function
CONTROL TERMINAL BOARD (Continued)		
THR	External thermal trip command	With THR-CM (open), OH trip will occur and the motor will coast-to-stop. NOTE: With no external thermal relay or external braking resistor thermostat, the THR-CM terminals must be closed or the Drive will not operate. THR-CM is factory pre-jumpered, remove prior to connecting an external NC contacts.
FMA*	Analog Frequency Meter Connection F_40=0	Provides an output of 0 to +10 VDC (+10VDC at max frequency), available for connection of a voltmeter with internal resistance of 10K ohms. See Function Code 41 for monitoring selection. Meter connects between terminal FMA & 11. Note: FMP cannot be used
FMP*	Digital Frequency Meter Connection F_40=1	Pulse frequency output equal to Drive output frequency. Pulse voltage: Peak 5 VDC, 50% duty. Adjustable range = 600 to 6000 Hz (Max) See Function Code 42 Pulse Rate Multiplier. Meter connects between FMP and CM. Note: FMA cannot be used
30A 30B 30C	Fault Relay Output Terminals	During normal operation, the relay is not energized and contact is made between 30B and 30C. When a fault is detected, the relay is energized and contact is made between 30A and 30C. (Contact rating resistive load: 250 VAC, 0.3 Amps)
X1-X3	Multistep Frequency Input Function Selection	Seven individual preset frequency selections via binary combination (closure) between X1, X2, X3, and CM. Frequency selections determined using functions F_21 thru F_27.
X4	Function Extension (Input)	F_43=0 acceleration/deceleration time #2 is selected when X4-CM is closed. When not closed #1 setting is activated. (F_43=1) 8 additional frequencies can be selected by X1, X2, X3 and X4. (F_43=2) 2nd Motor selection when X4 - CM is closed. (F_43=3) Functions as hold signal if 3-wire operation is desired.
Y1	Output Function (Programmable)	Outputs one of the following signals depending on setting of F_54: 0: Drive running (RUN) 3: Undervoltage stop mode (LV) 1: Frequency level detection (FDT) 4: Torque limiting mode (TL) 2: Frequency equivalence (FAR) 5: Auto restart mode after momentary power loss (IP) Allowable load: Maximum 27VDC, 50mA or less
PLC	PLC	Prevents PLC fault caused by leakage current from the drive. (See Drive interface details, Figure 4-7)

* Either an analog (FMA) or digital (FMP) frequency meter, not both.

Drive Interface Details

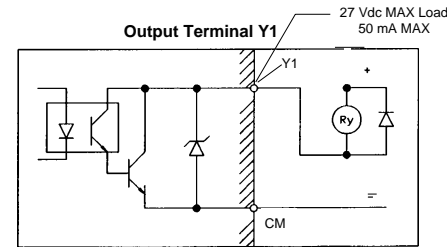

Input Terminal FWD, REV, X1-X4, BX, RST, THR

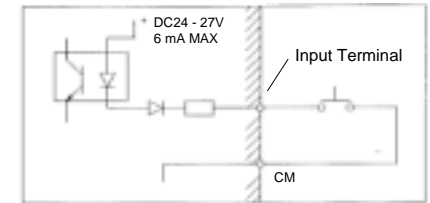

Reference Input

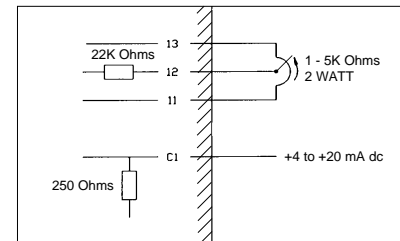

With PLC Terminal Connection Between PLC and Drive

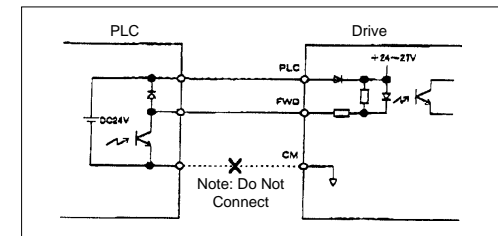

Figure 4-7. DRIVE INTERFACE DETAILS

Section 5 DRIVE OPERATION

PRE-OPERATION INSPECTION

After mounting and wiring has been completed, check the Drive for the following items before applying AC power:

- Check for wiring errors.
- Verify that there are no wiring chips, screws, etc. remaining in the Drive.
- Check that all screw and terminal connections are tight.
- Verify that no exposed wire ends are touching other terminals.

KEYPAD PANEL IDENTIFICATION / OPERATION

See the following diagrams for Display and Keypad Operation description when in the Operation Mode, Program Mode or Trip Mode.

FUNCTION CODE AND DATA CODE DESCRIPTION / SELECTION

When AC power is applied to the Drive, the keypad panel display will be as shown in Figure 5-1 and will be flashing on and off. If the **RUN** key is pressed at this point, operation will be at 60 Hertz according to the Function Code set at the factory. (Use the **STOP** key to halt operation.)

- A Flashing display indicates when a run command is not present.
- A Solid display indicates the actual output when the Drive is running.

If a test run is desired, press the key to change the flashing display of 60.00 Hz frequency setting to 5.00 Hz. Press **RUN** to conduct the test run and check for smooth motor operation and direction of rotation. Removal of AC power will store a frequency reference in memory.

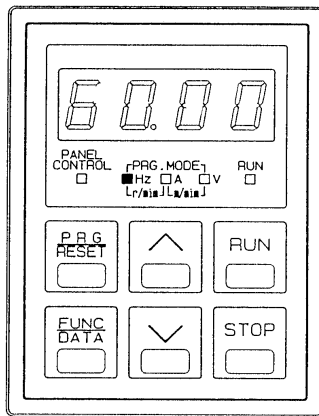

Figure 5-1. KEYPAD PANEL DISPLAY WHEN AC POWER IS APPLIED

Keypad and Display Operation Programming

Mode Selection

The Drive has five (5) modes as shown below. The mode can be changed with the keys on the keypad panel.

- | | |
|---------------------------------|------------------------------------|
| (1) Stop Mode: Drive stopped | (4) Program Mode: Motor Running |
| (2) Run Mode: Drive operational | (5) Trip Mode: Drive system faults |
| (3) Program Mode: Motor Stopped | |

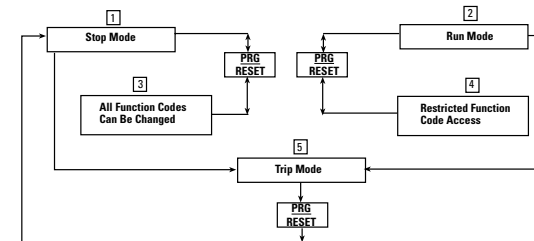

Data Setting

① Changing Function Codes in the STOP Mode

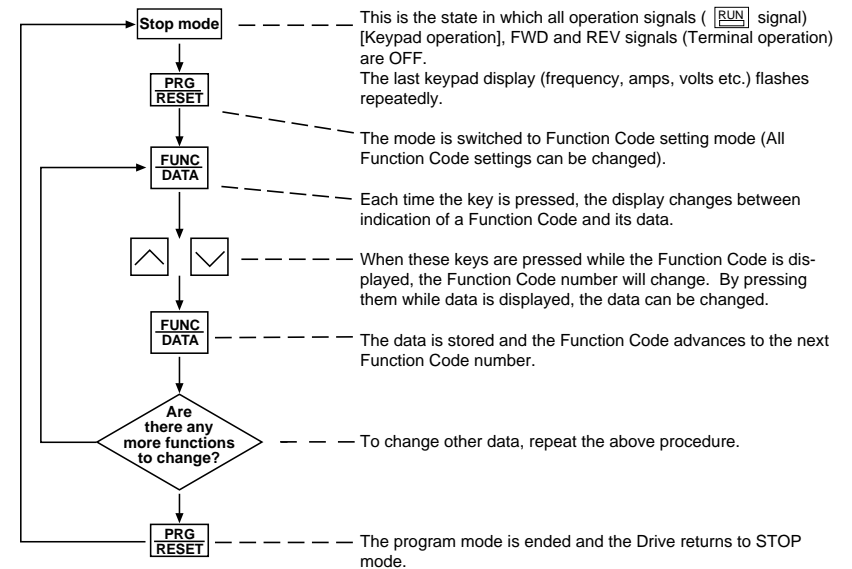

② Changing Function Codes in the RUN Mode (See TABLE 6)

Display and Key Operation

1. Operations and displays in each mode

The keypad panel modes can generally be classified into five types. The operation method and the display contents of each mode are shown below.

NOTE: Following examples are with maximum frequency, F_03 set higher than 60 Hz

① STOP Mode (Display continually flashes)

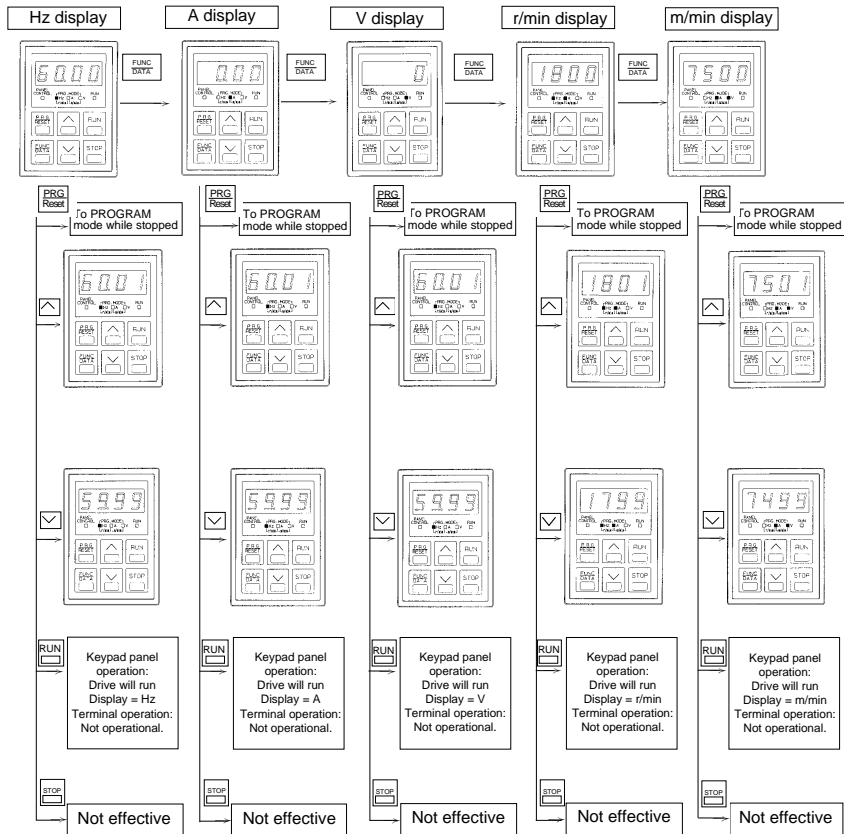

② RUN Mode

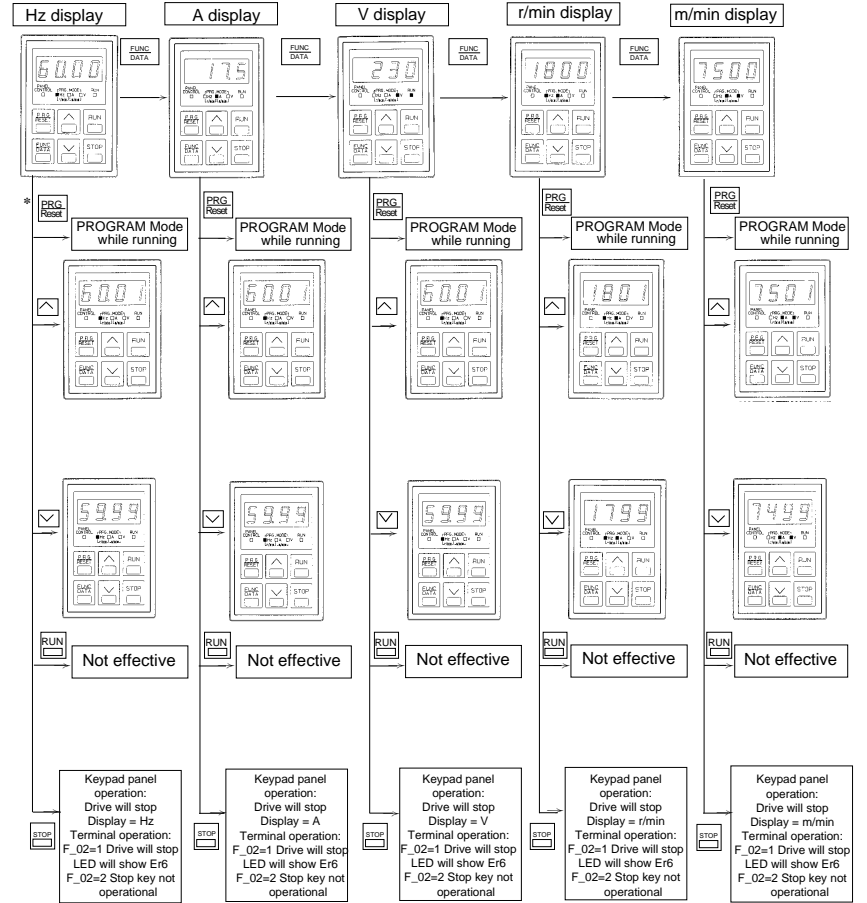

* NOTE: See TABLE 6 (page 5-12) for Functions that can be changed while in RUN Mode.

③ PROGRAM mode while stopped (example: changing the Torque Boost 1 data)

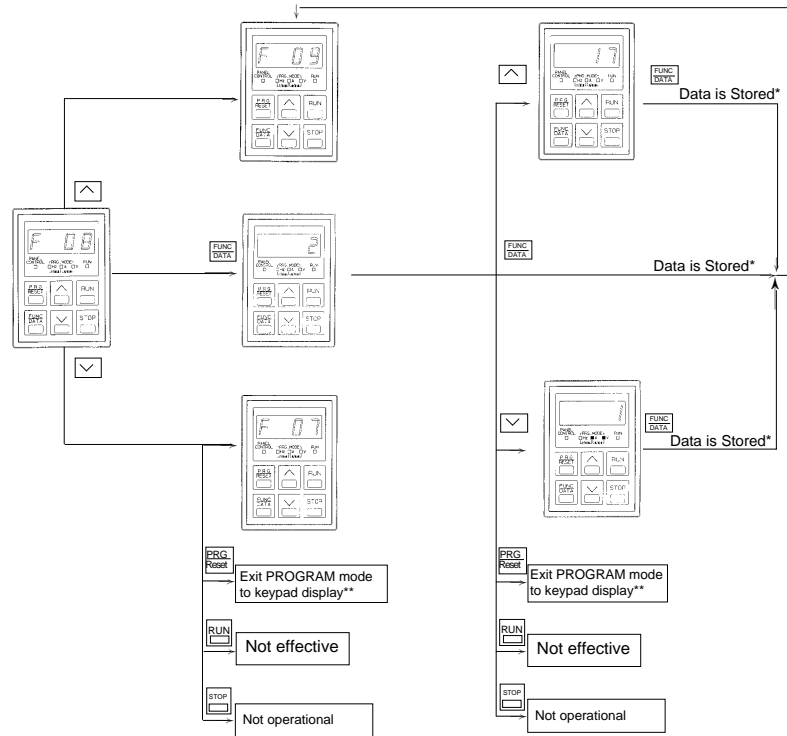

*NOTE: After changing function data with \uparrow \downarrow keys, the FUNC DATA key must be pressed. If this is not done, the data will not be stored. If the PRG/Reset key is pressed before FUNC DATA key is pressed, the changed data will be canceled and operation will continue with the previous data.

** NOTE: Keypad displays Frequency, Amps, Voltage, etc. based on selection.

④ PROGRAM mode while running (example: changing the Torque Boost 1 data)

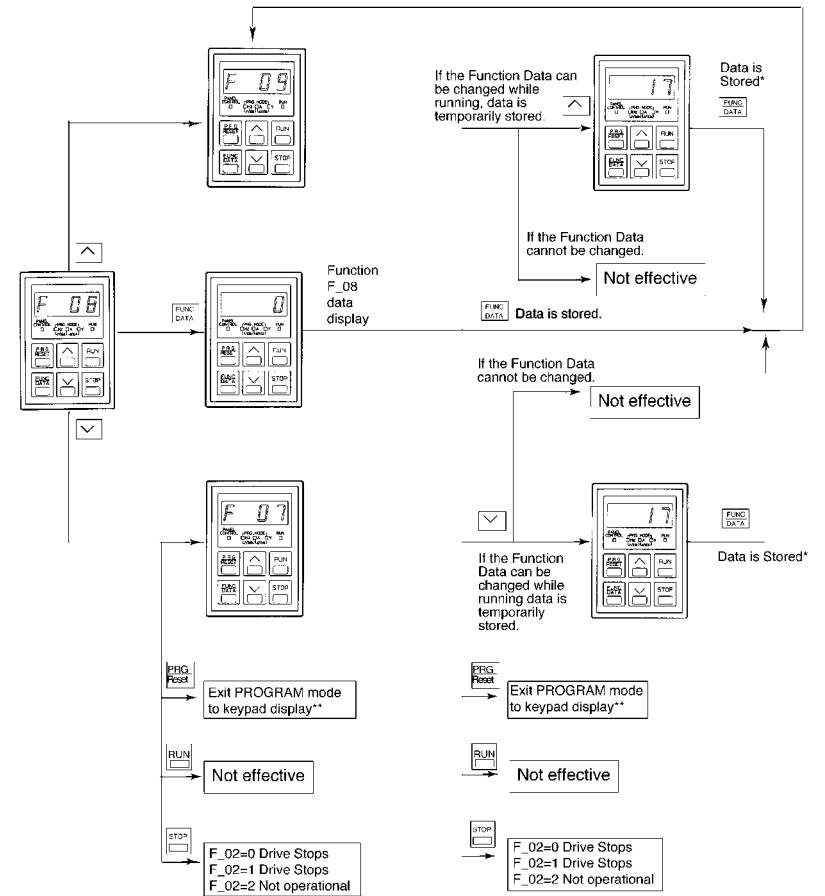

*NOTE: After changing function data with \uparrow \downarrow keys, the FUNC DATA key must be pressed. If this is not done, the data will not be stored. If the PRG/Reset key is pressed before FUNC DATA key is pressed, the changed data will be canceled and operation will continue with the previous data.

** NOTE: Keypad displays Frequency, Amps, Voltage, etc. based on selection. See Table 6 for Functions that can be changed while in RUN mode.

⑤ TRIP mode

NOTE: Past fault records also can be displayed with Function Code 29.

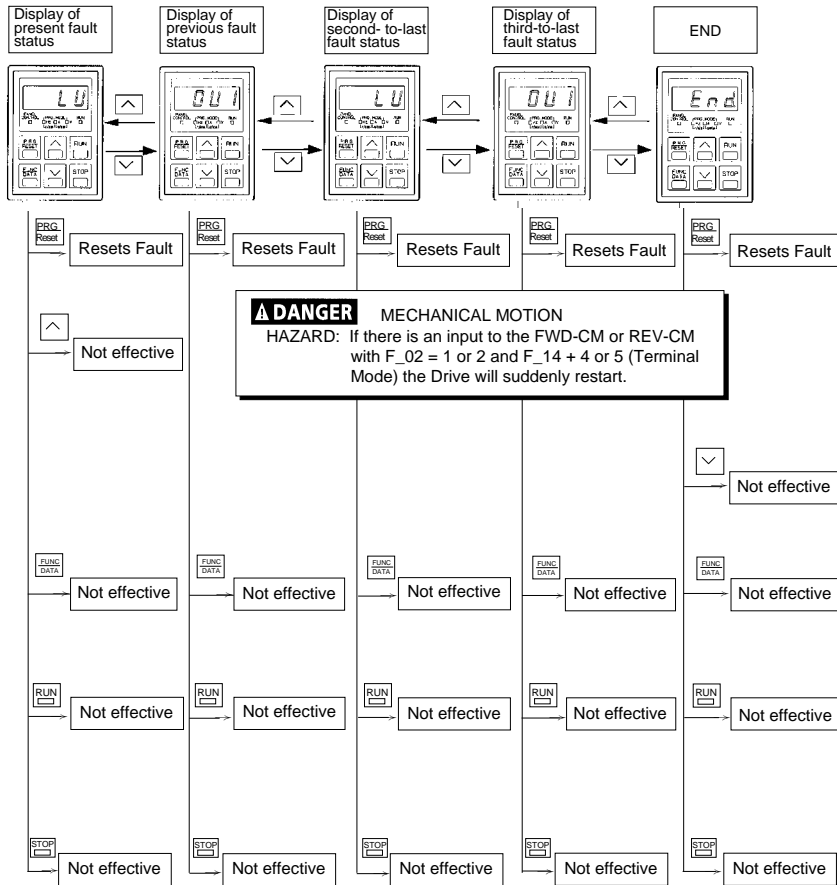

Summary of each operation mode : The following table shows a summary of the various modes.

Keys and Indicators	Mode Function	Indication	STOP Mode	RUN Mode	PROGRAM Mode	PROGRAM Mode	TRIP Mode
			Display output frequency, current, voltage, motor speed or line speed	Display output frequency, current, voltage, motor speed or line speed	While Stopped	While Running	Display fault status and fault memory listing
	Indication	Repeated Flashing	Unit display for output frequency, current, voltage, motor speed or line speed	Lit	Indicates PROGRAM mode	Lit	None
				Repeated Flashing	Indicates PROGRAM mode	Lit	Not Lit
	Function	Indicates whether Keypad Panel or Terminal Operation Selected	Lit during Keypad Panel Operation	Lit	Indicates PROGRAM mode	Lit	None
			Indicates Running	Indicates Stopped	Indicates Running	Indicates Fault	
	Indication	Not Lit	Lit	Not Lit	Lit	Not Lit	Not Lit
	Function	Program Mode	Program Mode	Stop Mode	Run Mode	Indicates Fault	Indicates Fault
	Function	Switches Digital Monitor & LED's Unit indicates displayed values	Increases and decreases frequency, motor speed or line speed settings	Increases and decreases Function Codes and data (stores data temporarily)	Increases and decreases Function Codes and data (stores data temporarily)	Not Effective	Not Effective
	Function	Change to Run Mode	Change to Stop Mode or 1 (F_02=0) or (F_02=1)	Not Effective	Change to Program Mode while Stopped (F_02=0)	Not Effective	Displays Fault Memory
	Function	Change to Run Mode	Change to Stop Mode or 1 (F_02=0) or (F_02=1)	Not Effective	Change to Program Mode while Stopped (F_02=0)	Not Effective	Not Effective
	Function	Not Effective	Not Effective	Not Effective	Not Effective	Not Effective	Not Effective

Operation

Pre-Operation Inspection

After completion of installation and wiring work, inspect the following items before the power supply to the Drive is switched on.

CAUTION:

1. Check for wiring errors. (Especially the main circuit wiring: connection of the three (single) phase AC power supply to the terminals L1, L2, L3 (L1, L2)).
2. Check that all loose wire strands, metal chips and unnecessary screws, etc. have been removed.
3. Check that all screws, terminals, and components are tight.
4. Check that the wire ends of crimp terminals are not in contact with other terminals.

CAUTION: Megger Test:

Do not conduct megger tests between the Drive main circuit terminals, or control circuit terminals. Refer to Section 7 "Maintenance and Inspection."







Test Run Check Points

Use a low frequency reference setting of about 5 Hz to test Drive operation. The following operating conditions must be confirmed:

1. Smooth motor rotation.
2. Correct direction of equipment rotation.
3. No abnormal vibrations and noise from the motor over full speed range.
4. Smooth acceleration and deceleration over full speed range.

Selecting Operation Method

The following methods can be selected to input the RUN/STOP signals and for frequency setting.

	Run/Stop	Data *1	Frequency setting	Data
1	Keypad panel operation		  Keys	$F \quad \square \quad \square \quad \square = \square \quad \square \quad \square \quad \square$
2	  Keys	$F \quad \square \quad \square \quad \square = \square \quad \square \quad \square \quad \square$	Analog signal (4 to 20 mA dc) or (0 to 10Vdc)	$F \quad \square \quad \square \quad \square = \square \quad \square \quad \square \quad \square$
3			Multistep speed selection by terminals X1, X2, and X3 *2	Either of the above data is acceptable.
4	Terminal operation (operation by external signal, FWD, REV terminals)	*3	  Keys	$F \quad \square \quad \square \quad \square = \square \quad \square \quad \square \quad \square$
5		$F \quad \square \quad \square \quad \square = \square \quad \square \quad \square \quad \square$	Analog signal (4 to 20 mA dc) or (0 to 10Vdc)	$F \quad \square \quad \square \quad \square = \square \quad \square \quad \square \quad \square$
6		or $\square \quad \square \quad \square \quad \square = \square \quad \square \quad \square \quad \square$	Multistep speed selection by terminals X1, X2, and X3 *2	Either of the above data is acceptable.

NOTES:

*1: F_02 cannot be changed when there is a short circuit (jumper) between either FWD-CM or REV-CM.

*2: Multistep speed operation (up to 8 steps are possible)

The frequencies of step 1 to step 7 are set with the Function Codes F_21 to F_27 and selected with the terminals X1, X2 and X3 (Additional 8 steps available with F_43 = 1 and F_44 to F_51 using X4).

If input signals are provided to terminals X1, X2 and X3, then data setting of F_01 (settings made by keypad panel or analog signal are ignored) and multistep speed operation is controlled by these terminal signals.

*3: F_02 = 1 Stop key on the keypad active

F_02 = 2 Stop key on the keypad inactive

TABLE 6: Function Codes

Function Code Numbers Followed by Function Descriptions

* Function can be changed while the Drive is operating.

BasicFunctions	Page 6-	BasicFunctions(cont'd)	Page 6-	BasicFunctions(cont'd)	Page 6-
00	Data Protection	1	22	* Multistep Frequency Setting 2	10
01	Frequency Command	1	23	* Multistep Frequency Setting 3	10
02	Operation Command	3	24	* Multistep Frequency Setting 4	10
03	Maximum Frequency	3	25	* Multistep Frequency Setting 5	10
04	Base Frequency 1	3	26	* Multistep Frequency Setting 6	10
05	Maximum Output Voltage	4	27	* Multistep Frequency Setting 7	10
06	* Acceleration Time 1	4	28	S-curve Acceleration/Deceleration (Operation Selection)	11
07	* Deceleration Time 1	4	29	* Fault Memory/History	12
08	* Torque Boost 1	4	30	Starting Frequency	12
09	* FMA Terminal Voltage Adjustment	5	31	* (During Accel/Decel) Torque Limit	12
10	* Number of Motor Poles	5	32	* (At Constant Speed)	12
11	* Line Speed Display Coefficient	5	33	Braking Torque Selection	13
12	* Motor Sound (Carrier Freq.)	5	34	* Bias Frequency	13
13	Number of Restart Attempts	6	35	* Gain for Frequency Setting Signal	14
14	Restart After Momentary Power Failure	6	36	* High Frequency Limiter	15
15	Electronic Overload 1 Selection	7	37	* Low Frequency Limiter	15
16	Electronic Overload Setting 1	8	38	* Motor Characteristics	15
17	DC Brake Operation	9	39	Data Initialization (Default Settings)	15
18	* DC Brake Starting Frequency	9	40	FMA, FMP terminals (Operation Selection)	16
19	* DC Braking Level	9	41	FMA Terminal (Function)	16
20	* DC Braking Time	9	42	* FMP Pulse Rate Multiplier	16
21	* Multistep Frequency Setting 1	10			
43	X4 Terminal Function	17			
44	* Multistep Frequency Setting 8	17			
45	* Multistep Frequency Setting 9	17			
46	* Multistep Frequency Setting 10	17			
47	* Multistep Frequency Setting 11	17			
48	* Multistep Frequency Setting 12	17			
49	* Multistep Frequency Setting 13	17			
50	* Multistep Frequency Setting 14	17			
51	* Multistep Frequency Setting 15	17			
52	* Signal Filter Frequency Setting	18			
53	Timer	18			
54	Y1 Terminal (Function)	19			
55	* Frequency Level Detection (FDT Operation Level)	19			
56	* Hysteresis Width	20			
57	THR Terminal (Function)	20			
58	* Jump Frequency Hysteresis	21			
59	* Jump Frequency 1	21			
60	* Jump Frequency 2	21			
61	* Jump Frequency 3	21			
62	Base Frequency 2	21			
63	* Acceleration Time 2	21			
64	* Deceleration Time 2	21			
65	* Torque Boost 2	22			
cont'd on next page					

LED Data Display	Setting	Description	Factory Setting	Customer Setting
	3	<p>The initial value for frequency setting is always zero after the drive is stopped by operation command or after power shut off.</p> <p>Same as data setting 2 except the initial value for frequency setting is the previous value before the drive is stopped by operation command or power shut off.</p> <p>Example of UP/DOWN control operation</p> <p>*1) Initial value = 0 *2) Initial value = previous value *3) 1st Acc. time by F06 *4) 1st Dec. time by F07 *5) 2nd Acc. time by F63 *6) 2nd Dec. time by F64</p>		
		<p>The diagram shows two cycles of frequency change. In the first cycle, the frequency starts at 0, ramps up (labeled *5), reaches a peak, and ramps down (labeled *6). The second cycle starts with a non-zero initial value (labeled *1), ramps up (*5), reaches a peak, and ramps down (*4). Control signals FWD-CM, X1-CM, and X2-CM are shown as pulses corresponding to the frequency changes.</p>		
		<p>The diagram shows two cycles of frequency change. The first cycle starts at 0, ramps up (labeled *3), reaches a peak (labeled *2), and ramps down (labeled *4). The second cycle starts at 0, ramps up (labeled *3), reaches a peak (labeled *2), and ramps down (labeled *4). Control signals FWD-CM, X1-CM, and X2-CM are shown as pulses corresponding to the frequency changes.</p>		
		<p>*Default value = 0 Factory setting for NEMA1 = 1. Will reset to 0 when default is selected</p>		

LED Data Display	Setting	Description	Factory Setting	Customer Setting
F_02	0 1 2	<p>OPERATION COMMAND</p> <p>Selection of the input method for operation commands</p> <p>0 Operation command input using the keypad (RUN and STOP keys)</p> <p>1 Operation command input by means of the external signal terminal (FWD, REV). STOP key on the keypad is active.</p> <p>2 Operation command input by means of the external signal terminal (FWD, REV). STOP key on the keypad is inactive.</p> <p>If selection "1" is chosen, and the stop button is depressed while the drive is running, the drive will perform the normal stop sequence until when the output frequency reaches zero at which point an "Er6" fault shall be indicated on the LED.</p> <p>NOTE: To change the Operation Command Setting the following three conditions must be met:</p> <ol style="list-style-type: none"> 1. Remove jumper between CM to FWD 2. Open between CM to FWD and CM to REV 3. F_43 = 3 for Three Wire Control cannot be selected. 	0/1*	
F_03	50 to 400	<p>MAXIMUM FREQUENCY</p> <p>Maximum operating frequency can be set within the range of 50 to 400 Hz in steps of 1 Hz.</p> <p>WARNING: Prior to operating a motor above its base frequency, you must review the operational capabilities of the motor. Failure to do so could result in severe damage to the motor and could result in injury to personnel.</p>	60	
F_04	15 to 400	<p>BASE FREQUENCY 1</p> <p>The range is 15 to 400 Hz in steps of 1 Hz. Normally set to the rated nameplate frequency of the motor.</p> <p>NOTE: If the Base Frequency is greater than the Maximum Frequency, the output voltage will not rise to the rated voltage. Set so that the ratio between the Base Frequency and the Maximum Frequency is less than 1:8.</p>	60	
		<p>*Default Value = 0 Factory Setting for NEMA 1 = 1 Setting will reset to 0 when default is selected</p>		

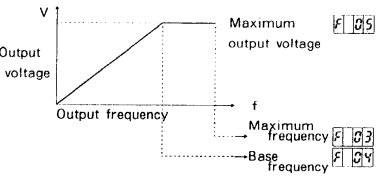
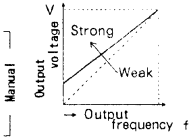
LED Data Display	Setting	Description	Factory Setting	Customer Setting										
F_05	80 to 230/240 ▲ 160 to 480	<p>MAXIMUM OUTPUT VOLTAGE This sets the maximum output voltage for the Drive in steps of 1V (230V/240V▲) and 2V (480V).</p> <p>NOTE: The output voltage cannot be higher than the voltage input from the power supply.</p> 	230 460											
*F_06 *F_07	0.01 to 3600	<p>ACCELERATION TIME 1 DECELERATION TIME 1 The time from start to maximum frequency (acceleration) and from maximum frequency to stop (deceleration) can be set within the range of 0.01 to 3600 seconds. Set values according to the load characteristics for Wk^2.</p> <table border="1" data-bbox="367 885 577 998"> <thead> <tr> <th>Setting Range</th> <th>Setting Step</th> </tr> </thead> <tbody> <tr> <td>0.00* to 9.99s</td> <td>0.01s</td> </tr> <tr> <td>10.0 to 99.9s</td> <td>0.1s</td> </tr> <tr> <td>100 to 999s</td> <td>1s</td> </tr> <tr> <td>1,000 to 3,600s</td> <td>10s</td> </tr> </tbody> </table> <p>* When set to 0.00 the time becomes 0.01 seconds.</p>	Setting Range	Setting Step	0.00* to 9.99s	0.01s	10.0 to 99.9s	0.1s	100 to 999s	1s	1,000 to 3,600s	10s	6.0 6.0	
Setting Range	Setting Step													
0.00* to 9.99s	0.01s													
10.0 to 99.9s	0.1s													
100 to 999s	1s													
1,000 to 3,600s	10s													
*F_08	0 1 2 3 31	<p>TORQUE BOOST 1 Torque boost can be set to optimize the V/Hz characteristics of the Drive according to the type of load the motor will see. Set only high enough to develop sufficient low frequency torque; too high of a value will cause diminished performance and excessive motor heating.</p> <p>0 Torque boost is automatically controlled 1 Squared torque characteristics (for fans and pumps) 2 Proportional torque characteristics (Weak) 3 (Weak) 31 (Strong)</p> 	2											
		▲ 240V is for single phase input only.												

LED Data Display	Setting	Description	Factory Setting	Customer Setting						
*F_09	0 to 99	<p>FMA (Analog Meter) VOLTAGE ADJUSTMENT This function adjusts the full scale voltage level of the analog voltage signal from the FMA terminal. 0: Approx. 6.5V 99: Approx. 10.5V</p> <p>The value can be adjusted to one of 100 settings within this range.</p> <p>NOTE: This function is only active if F_40 = 0 (FMA terminal output). Select the type of signal output from the FMA terminal by means of F_41 (FMA terminal function selection).</p>	85							
*F_10		<p>MOTOR POLES This sets the number of poles of the motor being used for synchronous speed display. 2 : 2 poles 6: 6 poles 10: 10 poles 4 : 4 poles 8: 8 poles 12: 12 poles</p> <p>Example: If running a 4-pole motor at 60 Hz, the display will be $120 \times 60 \div 4 = 1800$.</p> <p>If running a 4-pole motor at 50 Hz, the display will be $120 \times 50 \div 4 = 1500$.</p>	4							
*F_11	0.01 to 200.0	<p>LINE SPEED DISPLAY COEFFICIENT This sets the display coefficient for displaying the line speed [m/min.] Display value [m/min.] = Output frequency [Hz] x display coefficient</p> <table border="1" data-bbox="1438 941 1732 1031"> <thead> <tr> <th>Display Coefficient Setting Range</th> <th>Setting Step</th> </tr> </thead> <tbody> <tr> <td>0.01 to 9.99</td> <td>0.01</td> </tr> <tr> <td>10.0 to 200.0</td> <td>0.1</td> </tr> </tbody> </table>	Display Coefficient Setting Range	Setting Step	0.01 to 9.99	0.01	10.0 to 200.0	0.1	0.01	
Display Coefficient Setting Range	Setting Step									
0.01 to 9.99	0.01									
10.0 to 200.0	0.1									
*F_12	0 to 15	<p>MOTOR SOUND ADJUSTMENT (Carrier Frequency) This adjusts the carrier frequency of the Drive within the range of 0.75 to 15 kHz. The acoustic and electromagnetic noise generated by the motor increases as the carrier frequency is decreased. If set to 0, the carrier frequency will be set to 0.75 kHz (maximum noise). The adjustment from 1 to 15 kHz can be carried out in 1 kHz steps. NOTE: The higher the carrier frequency, the greater the adverse affects on the motor insulation.</p>	2							

LED Data Display	Setting	Description	Factory Setting	Customer Setting
F_13	0 b 10	<p>NUMBER OF RESTART ATTEMPTS</p> <p>This sets the number of times the Drive automatically tries to restart after a trip caused by overcurrent or overvoltage within the range of 0 to 10 times with F_14 = 4 or 5.</p>	0	
<div style="border: 1px solid black; padding: 5px; width: fit-content; margin: auto;"> <p>⚠ WARNING If the retry function has been activated and a trip occurs, the Drive will restart automatically depending on the cause of the trip. Make sure that the system is set up properly so that there will be no danger to personnel when the Drive starts, otherwise accidents may occur.</p> </div>				
F_14	0 1 2 3 4 5	<p>RESTART AFTER MOMENTARY POWER FAILURE (Operation Selection)</p> <p>This sets the operation mode when a momentary power failure occurs and when power is restored.</p> <p>0: Alarm LU activates, drive output immediately ceases. If power outage is lengthy and AC power is reapplied with a run command present, error "Er6" will occur. Also, resetting of faults while a run command is present shall not be allowed.</p> <p>1: Drive output immediately ceases, alarm LU activates upon power recovery. If power outage is lengthy and AC power is reapplied with run command present, error "Er6" will occur. Also resetting of faults while a run command is present will not be allowed.</p> <p>2: Alarm LU does not activate, drive output ceases (i.e. motor coasts) awaiting reapplication of power. If power outage is momentary, drive output resumes at frequency at the time of power failure. If, however, output is lengthy and AC power is reapplied with a run command present, error "Er6" will occur. Also resetting of faults while a run command is present shall not be allowed.</p> <p>3: Alarm LU does not activate, drive output ceases (i.e. motor coasts) awaiting reapplication of power. If power outage is momentary drive output resumes at frequency = 0. If, however, output is lengthy and AC power is reapplied with a run command present, error "Er6" will occur. Also resetting of faults while a run command is present shall not be allowed.</p> <p>4: Alarm LU does not activate, drive output ceases (i.e. motor coasts) awaiting reapplication of power. If power outage is momentary the same behavior as setting of "2" occurs. If power outage is lengthy and AC power is reapplied with a run command present, the drive will start up normally. Resetting of faults is allowed even if a run command is present.</p> <p>5: Alarm LU does not activate, drive output ceases (i.e. motor coasts) awaiting reapplication of power. If power outage is momentary the same behavior as setting of "3" occurs. If power outage is lengthy and AC power is reapplied with a run command present, the drive will start up normally. Resetting of faults is allowed even if a run command is present.</p>	0	
<div style="border: 1px solid black; padding: 5px; width: fit-content; margin: auto;"> <p>⚠ WARNING If restarting (data 4 or 5) is selected for the restart after momentary power failure function, the drive will restart after power is restored</p> </div>				

LED Data Display	Setting	Description	Factory Setting	Customer Setting
F_15		<p>ELECTRONIC OVERLOAD 1</p> <p>The Drive's Electronic Overload can be selected to help protect the motor from thermal overload due to various operating conditions. Selection should be based on operating conditions, type of load, motor thermal characteristics, applicable NEC and local electrical code requirements.</p> <p>The motor thermal characteristics and the diagram shown in Function Code 16 should be reviewed. Their characteristics should be coordinated to determine what is the protection level available with the Drive/motor combination, and what additional protection will be required (Refer to Function Code 16).</p>	1	
	0 1 2	<p>0 Inactive (External motor thermal overload device)</p> <p>1 Active (Review motor thermal characteristics)</p> <p>2 Special factory setting for forced air cooled motor. (Consult Motor Manufacturer)</p>		
	1	<p>1) For a standard 4-pole motor</p>		
	2	<p>2) For a special design motor</p>		

LED Data Display Setting Description Factory Setting Customer Setting

F_15
(cont'd)

1) For a standard 4-pole motor

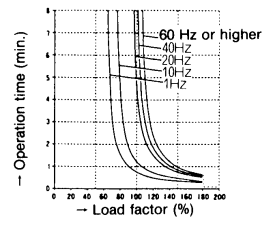

2) For a special design motor

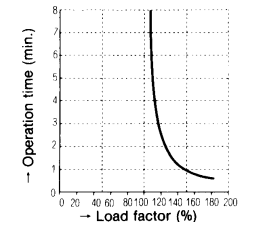

F_16

0.01 to 99.9

ELECTRONIC OVERLOAD LEVEL
The level for the electronic overload protection algorithm (see Function Code 15) can be adjusted from the factory default setting of rated Drive nameplate amps. The setting range is approximately 20 to 105% of rated Drive current.

Rated Current (A)
(Std. 4-Pole Motor)

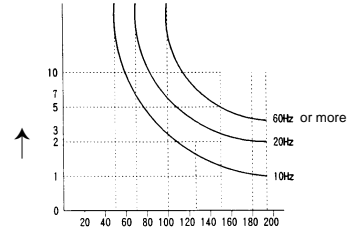

LED Data Display Setting Description Factory Setting Customer Setting

F_17

DC BRAKE (Operation Selection)
This selects the DC brake operation to active or inactive

0: Inactive - (Regenerative braking only)
1: Active - (DC braking after regenerative braking)

0

*F_18

0to60 **DC BRAKE** (Starting Frequency)
Sets the frequency to start DC injection brake operation during deceleration.

0 Hz

*F_19

0to100 **DC BRAKE** (Brake Level)
Sets the output braking level (brake output) for the DC injection brake. The braking strength will vary depending on the characteristics of the motor.

50%

*F_20

0.00to30 **DC BRAKE** (Braking Time)
Sets the operation time for the DC injection brake.

0.5s

	Starting Range	Unit	Setting Step
Starting Frequency	0 ¹ to 60	Hz	1 Hz
Braking Level	0 to 100	%	1%
Braking Time	0.00 to 9.99 10.0 to 30.0	s	0.01 0.1

¹ If the data is set to "0", the frequency will be 0.2 Hz.

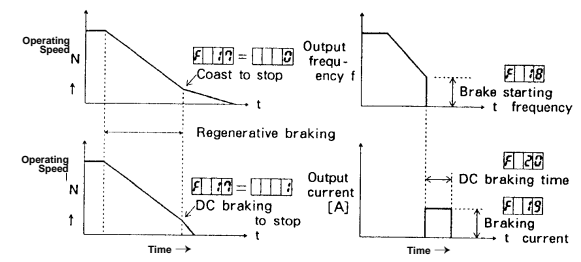

CAUTION The Drive braking function cannot be substituted for mechanical means. Attempting to do so may result in injury.

LED Data Display	Setting	Description	Factory Setting	Customer Setting
*F_21		MULTISTEP FREQUENCY #1	5.00Hz	
*F_22		MULTISTEP FREQUENCY #2	10.00Hz	
*F_23		MULTISTEP FREQUENCY #3	20.00Hz	
*F_24		MULTISTEP FREQUENCY #4	30.00Hz	
*F_25		MULTISTEP FREQUENCY #5	40.00Hz	
*F_26		MULTISTEP FREQUENCY #6	50.00Hz	
*F_27		MULTISTEP FREQUENCY #7	60.00Hz	

These Functions set the frequency for multistep frequency operation. The frequencies are selected as shown in the table below by setting control terminals X1-CM, X2-CM and X3-CM to ON/CLOSED.

[Relationship between terminals and multistep frequencies 1-7] * = ON/CLOSED

Function	1	21	22	23	24	25	26	27
Multistep Frequency	Speed 0	Speed 1	Speed 2	Speed 3	Speed 4	Speed 5	Speed 6	Speed 7
X1 - CM		•		•			•	•
X2 - CM			•	•			•	•
X3 - CM				•	•	•	•	•

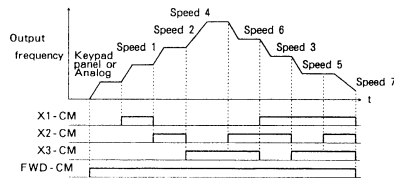

- (1) Speed 0 (when X1-CM, X2-CM and X3-CM are all OFF/OPEN) depends on the frequency setting method selected by means of function F_01. In other words, the setting becomes digital (using the \square and \square keys) or analog ([0 to 10VDC] or [4 to 20mA VDC]).
- (2) The actual operation frequency is limited by the maximum frequency F_03 and the frequency limiters F_36 and F_37.

LED Data Display	Setting	Description	Factory Setting	Customer Setting
F_28		S-CURVE ACCELERATION/DECELERATION (Operation Selection) Selects whether S-curve acceleration/deceleration is active or inactive and which of the two S-curve patterns is used. 0: Inactive - linear acceleration and deceleration (Fig. 1) 1: S-curve acceleration/deceleration (weak) Fig.2 2: S-curve acceleration/deceleration (strong) Fig. 3	0	

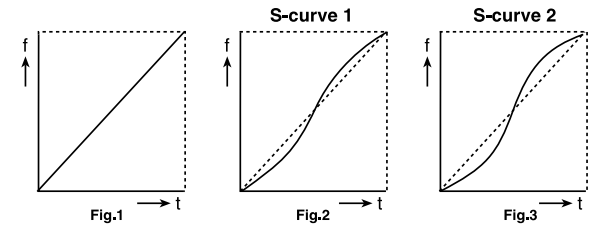

NOTE:



















- ① Shocks at the start and end of acceleration and deceleration can be softened by selecting a S-curve pattern.
- ② The maximum gradient in the output frequency when a S-curve pattern is selected is the same as for linear acceleration and deceleration time.
- ③ The actual acceleration and deceleration times when a S-curve pattern is selected is extended by 10% (when 1 is set) or 20% (when 2 is set) from the times set by F_06 and F_07 or by F_63* and F_64*.

* Alternate acceleration (F_63) and deceleration (F_64) times are selected when the terminal X4 function is set so that F_43 = 0 and X4-CM is ON/CLOSED.

LED Data Display Setting Description Factory Setting Customer Setting

*F_29 **PROTECTION HISTORY/FAULT MEMORY**
The Last 4 drive faults are displayed in order when the  key is pressed.

Operation Procedure

	Procedure	Display example	Remarks
1	call up   		
2	Press the  key.		
3	Press the  key.		Contents of the last trip are displayed.
4	Press the  key. Press the  key.		Contents of the second-last trip are displayed.
5	Press the  key. Press the  key.		Contents of the third-last trip are displayed.
6	Press the  key. Press the  key.		Contents of the fourth-last trip are displayed. This example shows there is no trip history for this.
7	Press the  key.		

F_30 0to15 **STARTING FREQUENCY**
This sets the starting frequency within the range of 0 to 15Hz in 1Hz steps. If the data is set to 0, the frequency will be 0.2Hz.

*F_31 **TORQUE LIMIT**
(During Acceleration/Deceleration)
Sets the Torque Limit level during acceleration/ deceleration in steps of 1%.

- 0 No limit
- 20 20% Limit
- to
- 180 180% Limit

*F_32 **TORQUE LIMIT**
(At Constant Speed)
This sets the torque limit level during constant speed operation in steps of 1%.

- 0 No limit
- 20 20% Limit
- to
- 180 180% Limit

WARNING If the torque limit function has been selected, the Drive may start running with differences in the acceleration/ deceleration time and speed settings. Make sure that the system is set up properly so that there will be no danger to personnel when the Drive starts, otherwise accidents may occur.

LED Data Display Setting Description Factory Setting Customer Setting

F_33 **BRAKING TORQUE SELECTION**
This sets the limit level for braking torque in accordance with the brake being used.

- 0 Low (no Dynamic Braking option)
 - 1 High (with Dynamic Braking option)
- NOTE:** Always connect an extra braking resistor. Contact GE Fuji Technical Services for proper brake resistor option selection.

*F_34 -400 to +400 **BIAS FREQUENCY**
This function adds the bias frequency offset to the analog reference frequency to produce the output frequency. The setting range is between -400 to +400Hz in steps of 1Hz.

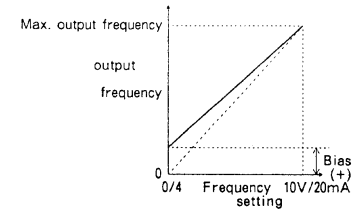

*The bias frequency is only active when the frequency setting function F_01 = 1

WARNING If the bias frequency has been set, the Drive will operate when an operation command is given, even if the analog frequency is zero.

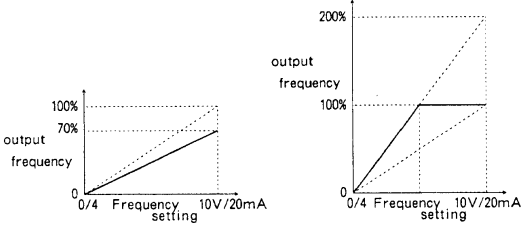
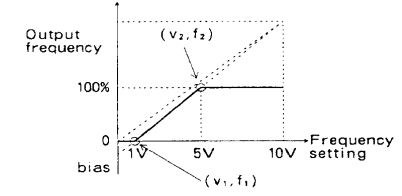
LED Data Display	Setting	Description	Factory Setting	Customer Setting
*F_35	0.00 to 250	<p>GAIN FOR FREQUENCY SETTING SIGNAL This sets the size (gradient) of the output frequency corresponding to the analog frequency setting as a percentage of the maximum frequency.</p>  <p>Example: If the bias frequency function (F_34) and the gain for frequency setting signal function (F_35) are used together, the gain for frequency setting signal has priority, and the bias is applied to the frequency with gain already applied. The bias frequency f_{bias} and setting frequency gain at this time can be calculated by the following formulas.</p> $f_{bias} = f_1 - \frac{f_1 - f_2}{V_1 - V_2} \times V_1$ $\text{Gain} = \frac{1000 \times (f_1 - f_2)}{100 \times (V_1 - V_2) + f_1 \times V_2 - f_2 \times V_1}$  <p>Example: If the analog frequency setting voltage is 1 to 5Vdc and the output frequency is weighted to 0 to 100% then: $(V_1, f_1) = (1, 0)$, $(V_2, f_2) = (5, 100)$, so that $f_{bias} = -25\%$ and gain = 200%</p>	100.0%	

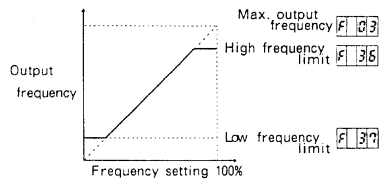
LED Data Display	Setting	Description	Factory Setting	Customer Setting										
*F_36	0to400	<p>HIGH FREQUENCY LIMITER</p>	70 Hz											
*F_37	0to400	<p>LOW FREQUENCY LIMITER The high and low limits for the output frequency can be set within a range of 0 to 400Hz in stages of 1Hz.</p>  <p>NOTE: If the high and low limit settings are reversed, the high limit has priority and the low limit is ignored.</p>	0 Hz											
*F_38	0to10	<p>MOTOR CHARACTERISTICS This adjusts the output current in cases where there is an irregularity such as current fluctuation. If a current fluctuation occurs, adjust the setting value while referring to the tables below.</p> <table border="1" data-bbox="1407 893 1806 958"> <thead> <tr> <th>Number of Motor Poles</th> <th>Higher – 4 – Lower</th> <th>Load</th> <th>High</th> <th>Low</th> </tr> </thead> <tbody> <tr> <td>Setting</td> <td>0 10</td> <td>Setting</td> <td>0</td> <td>10</td> </tr> </tbody> </table>	Number of Motor Poles	Higher – 4 – Lower	Load	High	Low	Setting	0 10	Setting	0	10	5	
Number of Motor Poles	Higher – 4 – Lower	Load	High	Low										
Setting	0 10	Setting	0	10										
F_39	0: 1:	<p>DATA INITIALIZATION This resets all Function Codes to factory settings.</p> <p>0: Inactive (manual setting) 1: Initial values (Initialization with factory defaults) [Operation Procedure] ① When 0 is being displayed, press the STOP + △ keys simultaneously to change the display to 1. ② In this condition, press the FUNC/DATA key to reset all data to the factory default settings. The display will then automatically switch to show the frequency setting for STOP mode.</p>	0											

LED Data Display	Setting	Description	Factory Setting	Customer Setting
F_40		FMA_FMP TERMINALS (Operation Selection) This switches the output destination for the external monitoring signal. 0: Analog signals are output from the FMA terminal. (The FMP terminal cannot be used.) The type of analog signal output to the FMA terminal is selected by function F_41. 1: Pulse signals are output from the FMP terminal. (The FMA terminal cannot be used.) Frequency of pulse signal output to the FMP terminal is adjusted by function F_42.	0	
F_41		FMA TERMINAL (Function selection) This sets the type of analog signal which is output to the FMA terminal. 0: Output frequency: 0 to 100% full scale 1: Output current: 0 to 200% full scale 2: Output torque: 0 to 200% full scale 3: Output power: 0 to 200% full scale	0	
*F_42	1 to 100	FMP TERMINAL (Pulse Rate Multiplier) This sets the pulse rate multiplier for the pulse signal frequency output to the FMP terminal with respect to the Drive output frequency. The setting range is 1 to 100. FMP terminal pulse frequency = Drive output frequency X [Pulse rate multiplier]	24	

LED Data Display	Setting	Description	Factory Setting	Customer Setting																																																						
F_43		X4 TERMINAL FUNCTION The function for the X4 input terminal can be selected from the following four options. 0: Functions as a command input terminal X4 for switching to acceleration/deceleration time 2. The acceleration time 2 and deceleration time 2 are set by F_63 and F_64. 1: Enables the use of multistep frequency settings 8 to 15. Frequencies 8 to 15 are set by means of F_44 to F_51. 2: Functions as a command terminal X4 for switching to base frequency 2 when using a second motor, etc. When base frequency 2 is selected, acceleration/ deceleration time 2, torque boost 2 and electronic overload 2 are selected simultaneously. Base frequency 2 is set using function F_62, acceleration/ deceleration time 2 are set by function F_63 and F_64, torque boost 2 is set by function F_65, and electronic overload 2 is set by F_66 and F_67. 3: Functions as a hold signal (HLD) for operation commands during 3-wire control operation.	0																																																							
*F_44		MULTISTEP FREQUENCY SETTING 8	0.00																																																							
*F_45		MULTISTEP FREQUENCY SETTING 9	0.00																																																							
*F_46		MULTISTEP FREQUENCY SETTING 10	0.00																																																							
*F_47	0 to 400	MULTISTEP FREQUENCY SETTING 11	0.00																																																							
*F_48		MULTISTEP FREQUENCY SETTING 12	0.00																																																							
*F_49		MULTISTEP FREQUENCY SETTING 13	0.00																																																							
*F_50		MULTISTEP FREQUENCY SETTING 14	0.00																																																							
*F_51		MULTISTEP FREQUENCY SETTING 15 These set the 8 multistep frequencies from frequency 8 to frequency 15 within the range of 0 to 400Hz. The setting step is the same as for functions F_21 through F_27. (Relationship between terminals and multistep frequencies 8 through 15) • = ON/CLOSED .	0.00																																																							
		<table border="1"> <thead> <tr> <th>Function</th> <th>44</th> <th>45</th> <th>46</th> <th>47</th> <th>48</th> <th>49</th> <th>50</th> <th>51</th> </tr> </thead> <tbody> <tr> <td>Multistep Frequency</td> <td>Speed 8</td> <td>Speed 9</td> <td>Speed 10</td> <td>Speed 11</td> <td>Speed 12</td> <td>Speed 13</td> <td>Speed 14</td> <td>Speed 15</td> </tr> <tr> <td>X1 - CM</td> <td></td> <td>•</td> <td></td> <td>•</td> <td></td> <td></td> <td>•</td> <td>•</td> </tr> <tr> <td>X2 - CM</td> <td></td> <td></td> <td>•</td> <td></td> <td></td> <td></td> <td>•</td> <td>•</td> </tr> <tr> <td>X3 - CM</td> <td></td> <td></td> <td></td> <td></td> <td>•</td> <td>•</td> <td>•</td> <td>•</td> </tr> <tr> <td>X4 - CM</td> <td>•</td> <td>•</td> <td>•</td> <td>•</td> <td>•</td> <td>•</td> <td>•</td> <td>•</td> </tr> </tbody> </table>	Function	44	45	46	47	48	49	50	51	Multistep Frequency	Speed 8	Speed 9	Speed 10	Speed 11	Speed 12	Speed 13	Speed 14	Speed 15	X1 - CM		•		•			•	•	X2 - CM			•				•	•	X3 - CM					•	•	•	•	X4 - CM	•	•	•	•	•	•	•	•		
Function	44	45	46	47	48	49	50	51																																																		
Multistep Frequency	Speed 8	Speed 9	Speed 10	Speed 11	Speed 12	Speed 13	Speed 14	Speed 15																																																		
X1 - CM		•		•			•	•																																																		
X2 - CM			•				•	•																																																		
X3 - CM					•	•	•	•																																																		
X4 - CM	•	•	•	•	•	•	•	•																																																		
NOTE: These functions are only active when F_43 = 1 (X4).																																																										

LED Data Display	Setting	Description	Factory Setting	Customer Setting												
*F_52	0.02to5.0	<p>FREQUENCY SETTING SIGNAL FILTER</p> <p>This Function Code is used to set the time constant for the input filter in order to eliminate the effects of noise present in the analog signals (voltage and current references). If the time constant set point is too long, the response to changes in analog commands will become inadequate for the required performance level. Adjustable from 0.02 to 5.00 seconds in 0.02 increments.</p>	.06s													
F_53	0 001to 3600	<p>TIMER (AUTOMATIC RUN/STOP CYCLE)</p> <p>This sets the timer to active or inactive, and also sets the time from the start of operation until operation automatically stops (when the timer is active).</p> <p><u>Inactive</u> (Normal Operation) <u>Active</u> (0.01 second) <u>Active</u> (3,600 seconds)</p> <table border="1"> <thead> <tr> <th>Setting Range</th> <th>Setting Step</th> <th>Unit</th> </tr> </thead> <tbody> <tr> <td>0.00 to 9.99</td> <td>0.01</td> <td rowspan="4">second (s)</td> </tr> <tr> <td>10.0 to 99.9</td> <td>0.1</td> </tr> <tr> <td>100 to 999</td> <td>1</td> </tr> <tr> <td>1000 to 3600</td> <td>10</td> </tr> </tbody> </table> <p>To restart the cycle, the closed FWD(REV)-CM has to be opened and then re-closed. F_02 = 1.</p> <p>When FWD (REV)-CM is opened during timer operation, the timer is cleared.</p> <p>When power failure occurs during timer operation, the timer is cleared.</p>	Setting Range	Setting Step	Unit	0.00 to 9.99	0.01	second (s)	10.0 to 99.9	0.1	100 to 999	1	1000 to 3600	10	0.00s	
Setting Range	Setting Step	Unit														
0.00 to 9.99	0.01	second (s)														
10.0 to 99.9	0.1															
100 to 999	1															
1000 to 3600	10															

6-18

LED Data Display	Setting	Description	Factory Setting	Customer Setting								
F_54		<p>Y1 TERMINAL FUNCTION (Function Selection)</p> <p>This selects the output signal for the Y1 terminal from the following 6 types:</p> <p>0: Drive running state (RUN) 1: Frequency level detection (FDT) Y1-CM is ON when the frequency detected is identical to the frequency set by function F_55. The hysteresis is set by function F_56. 2: Frequency equivalence signal (FAR) Y1-CM is ON when the frequency reaches the frequency set by the keypad panel, analog input, multistep frequency setting etc. The hysteresis is set by function F_56. 3: Under-voltage stop mode (LV) 4: Torque limiting mode (TL) 5: Auto-restart mode after momentary input power failure (IP)</p>	0									
*F_55	0.00to400.0	<p>FREQUENCY LEVEL DETECTION (FDT Operation Level)</p> <p>This sets the operation level for frequency detection signal (FDT) output within the range of 0.00 through 400.0 Hz (depends on F_03 setting). F_54 = 1</p> <p>Setting resolution:</p> <table border="1"> <thead> <tr> <th>Setting range</th> <th>Setting step</th> <th>Unit</th> </tr> </thead> <tbody> <tr> <td>0.00 to 99.99</td> <td>0.01</td> <td rowspan="2">Hz</td> </tr> <tr> <td>100.0 to 400.0</td> <td>0.1</td> </tr> </tbody> </table>	Setting range	Setting step	Unit	0.00 to 99.99	0.01	Hz	100.0 to 400.0	0.1	0.00 Hz	
Setting range	Setting step	Unit										
0.00 to 99.99	0.01	Hz										
100.0 to 400.0	0.1											

6-19

LED Data Display	Setting	Description	Factory Setting	Customer Setting															
*F_56	0to30	<p>HYSTERESIS WIDTH This sets the hysteresis for the frequency detection signal (FDT) and frequency equivalence signal (FAR) within the range of 0-30 Hz. The FAR is in the middle of the hysteresis width. F_54 = 2</p> <p>FAR SIGNAL (Y1-CM) OFF ON ON OFF</p>	0 Hz																
F_57	0: 1:	<p>THR TERMINAL (Function Selection) This sets the function for the THR input terminal. Used for THR functions (Trip Command Functions) Used for Edit Permit Commands THR-CM off: Function data change not possible. THR-CM on: Function data change possible.</p> <p>The relationship between this function and function F_00 (Data protection) is shown in the table below:</p> <table border="1"> <thead> <tr> <th>F_57 Edit permit command</th> <th>F_00 Data protection</th> <th>Data changing possible</th> </tr> </thead> <tbody> <tr> <td>0 (OFF)</td> <td>0</td> <td>No</td> </tr> <tr> <td>0 (OFF)</td> <td>1</td> <td>No</td> </tr> <tr> <td>1 (ON)</td> <td>0</td> <td>Yes</td> </tr> <tr> <td>1 (ON)</td> <td>1</td> <td>No</td> </tr> </tbody> </table>	F_57 Edit permit command	F_00 Data protection	Data changing possible	0 (OFF)	0	No	0 (OFF)	1	No	1 (ON)	0	Yes	1 (ON)	1	No	0	
F_57 Edit permit command	F_00 Data protection	Data changing possible																	
0 (OFF)	0	No																	
0 (OFF)	1	No																	
1 (ON)	0	Yes																	
1 (ON)	1	No																	

LED Data Display	Setting	Description	Factory Setting	Customer Setting
*F_58 *F_59 *F_60 *F_61	0to30 0to400 0to400 0to400	<p>JUMP FREQUENCY (Hysteresis) JUMP FREQUENCY 1 JUMP FREQUENCY 2 JUMP FREQUENCY 3 This sets the three midpoints and the hysteresis for the jump frequencies which are used to prevent vibration from occurring at certain frequencies due to mechanical resonance between the load and the motor. [Jump frequency 1] The midpoints for the frequencies [Jump frequency 2] to be jumped can be set in steps [Jump frequency 3] of 1 Hz.</p> <p>Output frequency Frequency setting f</p>	3 Hz 0 Hz 0 Hz 0 Hz	
F_62	15to400	<p>BASE FREQUENCY 2 This sets Base Frequency 2 to within a range of 15 to 400 Hz in steps of 1 Hz. It is used when the terminal X4 has been set to function as a command terminal for switching to Base Frequency 2 (F_43 = 2).</p> <p>NOTE: If the Base Frequency is greater than the Maximum Frequency, the output voltage will not rise to the rated voltage. Set the ratio between the Base Frequency and the Maximum Frequency to less than 1:8.</p>	60 Hz	
*F_63 *F_64	0.00to3600 0.00to3600	<p>ACCELERATION TIME 2 DECELERATION TIME 2 This sets the acceleration time 2 and deceleration time 2 when terminal X4 has been set to function as a command input terminal for switching to: acceleration/deceleration time 2 (X4: F_43 = 0) or to base frequency 2 (F_43 = 2).</p> <p>Setting details are the same as for function F_06 and F_07.</p>	10.0 s 10.0 s	

LED Data Display	Setting	Description	Factory Setting	Customer Setting
*F_65	1 2 3 to 31	TORQUE BOOST 2 This sets the torque boost 2 to one of 31 patterns when terminal X4 has been set to function as a command input terminal for switching to base frequency 2 (F_43 = 2). Setting details are the same as for function F_08. NOTE: For manual torque boost only; no pattern can be selected for automatic torque boost.	13	
F_66	SeeF_15	ELECTRONIC OVERLOAD 2 (Operation Selection)	0	
F_67	SeeF_16	ELECTRONIC OVERLOAD 2 (Operation Level) When terminal X4 has been set to function as a command input terminal for switching to base frequency 2 (F_43 = 2), this sets the electronic overload to 2 (motor overload detection) for the second motor to active or inactive, and also sets the operation pattern and the operation level. Setting details are the same as for function F_15 and F_16. NOTE: Base frequency 2, torque boost 2 and electronic overload 2 are only active when the X4 terminal function has been set to F_43 = 2 and X4-CM is ON/CLOSED.	Rated motor Current (Std. 4 Pole Motor)	
*F_68	0.0to5.0	SLIP COMPENSATION Functions to suppress fluctuations in the motor speed which result from variations in the load torque. The slip frequency with respect to the base frequency during rated load output (100%) can be set within the range of 0.0 to 5.0 Hz in steps of 0.1 Hz. If the slip compensation value is set to 0.0 Hz, then the slip compensation function will be inactive.	0.0 Hz	

6-22

LED Data Display	Setting	Description	Factory Setting	Customer Setting
F_69	0: 1:	TORQUE VECTOR CONTROL This selects whether Torque Vector Control is active or not. Torque Vector Control inactive Torque Vector Control active NOTE: Torque Vector Control does not function if is selected when the X4 terminal function has been set to (F_43 = 2) and X4-CM is ON/CLOSED. The manual torque boost selected by F_65 will apply. NOTE:ForbestresultsperformAutoTuningFunction (F_74)priortoactivationofTorqueVectorControl.	0	
F_70	0: 1: 2: 3:	MOTOR HP CAPACITY This sets the HP capacity of the motor which is connected in relation to the Drive capacity. 1-frame up capacity for standard applied motor Standard capacity for standard applied motor 1-frame down capacity for standard applied motor 2-frame down capacity for standard applied motor	1	
F_71	0.00	MOTOR 1 RATED CURRENT	4-pole	
F_72	to 99.9	MOTOR 1 NO-LOAD CURRENT These set the rated current (A) and no-load current (A) for the motor which is connected to the Drive.	4-pole (Std. Design B)	
F_73	0.00 to 99.9	EXPLANATION: The primary resistance (R ₁) and leakage reactance (X ₁) are automatically rewritten with the rated value of the motor capacity (F_70), motor 1rated current F_71 and motor 1no-load current (F_72) are set. MOTOR 2 RATED CURRENT This sets the rated current (A) for the second motor which is selected when base frequency 2 (F_62) is active.	Rated Current (Std. 4-Pole Motor)	

6-23

LED Data Display	Setting	Description	Factory Setting	Customer Setting
F_74	0: 1:	<p>AUTOMATIC TUNING This function is used to automatically tune the primary resistance (R1) and leakage reactance (X1) of the motor in order to achieve optimum performance of F_69 (Torque Vector Control).</p> <p>Inactive Automatic tuning [Operation procedure] ① Connect the motor and the Inverter correctly. ② Set the data for this function to "1" while the Inverter is stopped. ③ Press the FUNC DATA key.</p> <p>⇒⇒ Tuning operation (approx. 10 seconds) ⇒⇒ F_75 ↳ The display changes when tuning is completed. _____→ ④ The results of tuning can be confirmed using F_75 (R1) and F_76 (X1).</p>	0	
F_75	0.00to50	<p>MOTOR 1 (%R1 Setting) ▲ This function displays the primary resistance R1 of the motor in terms of percentage, and is set manually. The data can be overwritten and changed automatically by automatic tuning using function F_74, or by setting the motor capacity, rated current and no-load current using functions F_70 to F_72.</p> <p>Calculation Formula for %R1</p> $\%R1\blacktriangle = \frac{R1 + \text{cable R}}{V / (\sqrt{3} \cdot I)} \times 100 [\%]$ <p>R1: Motor resistance Cable R: Resistance of cable between Drive and motor V: Rated voltage of motor I: Rated current of motor ▲: Value calculated for Y connection</p>	Std. 4-Pole motor	

LED Data Display	Setting	Description	Factory Setting	Customer Setting																																			
F_76	0.00to50	<p>MOTOR 1 (%X Setting) ▲ This function displays the leakage reactance X1 of the motor in terms of percentage, and is set manually.</p> <p>The data can be overwritten and changed automatically by automatic tuning using function F_74, or by setting the motor capacity, rated current and no-load current using functions F_70 to F_72.</p> <p>Calculation Formula for %X1</p> $\%X1 = \frac{X1 + X2 = X_m / (X2 + X_m) + \text{cable X}}{V / (\sqrt{3} \cdot I)} \times 100 [\%]$ <p>X1: Primary inductance of motor 1[Ohm] X2: Secondary inductance of motor 1 [Ohm] Xm ▲ : Mutual inductance of motor 1 [Ohm] Cable X: [Ohm] V: Rated voltage of motor I: Rated current of motor ▲: Value calculated for Y connection</p>	Std. 4-pole motor																																				
<div style="border: 1px solid black; padding: 5px; width: fit-content; margin: 0 auto;"> <p>⚠ WARNING %R1 and %X1 should be set to values which are appropriate for the motor being used. The motor may not operate correctly if these values are not set correctly, which could result in accidents.</p> </div>																																							
*F_77	000to999	<p>TORQUE LIMITING RESPONSE (At Constant Speed)</p>	369																																				
*F_78	000to999	<p>TORQUE LIMITING RESPONSE (During Acceleration/Deceleration)</p> <table border="1" style="margin: 10px auto;"> <tr> <td style="border: none;">000 to 999</td> <td style="border: none;">P</td> <td style="border: none;">I</td> <td style="border: none;">(Quick)</td> <td style="border: none;">(Slow)</td> </tr> <tr> <td style="border: none;"> </td> <td style="border: none;"> </td> <td style="border: none;"> </td> <td style="border: none;">0 0</td> <td style="border: none;">. . . 9 9</td> </tr> <tr> <td style="border: none;">P I</td> <td style="border: none;">P I</td> <td style="border: none;">P I</td> <td colspan="2" style="border: none;"></td> </tr> <tr> <td style="border: none;">0 (Low)</td> <td colspan="4" style="border: none;"></td> </tr> <tr> <td style="border: none;">.</td> <td colspan="4" style="border: none;"></td> </tr> <tr> <td style="border: none;">.</td> <td colspan="4" style="border: none;"></td> </tr> <tr> <td style="border: none;">9 (High)</td> <td colspan="4" style="border: none;"></td> </tr> </table> <p>P – Represented by the Hundreds Digit (Gain Value) I – Represented by the Tens and Units Digit (Time Constant)</p>	000 to 999	P	I	(Quick)	(Slow)				0 0	. . . 9 9	P I	P I	P I			0 (Low)					.					.					9 (High)					394	
000 to 999	P	I	(Quick)	(Slow)																																			
			0 0	. . . 9 9																																			
P I	P I	P I																																					
0 (Low)																																							
.																																							
.																																							
9 (High)																																							
F_79	0: 1: 2: 3:	<p>OPTION SELECTION This function sets whether an option is being used or not, and also what type of option is being used if any.</p> <p>No Options DI option card used DI/O option card used RS option card used</p> <p>NOTE: For details on setting specifications when using an option card, refer to the instruction manual which is supplied with the option card.</p>	0																																				

Section 7 MAINTENANCE and INSPECTION

To prevent potential problems and provide long periods of trouble-free operation, the following checks should be periodically conducted.

CAUTION: Do not conduct any inspections until after disconnecting the power supply and after the "CRG" light on the Drive has gone out.

MEGGER TEST

1. Disconnect all Drive terminals and never apply test voltage to the Drive when conducting an external circuit megger test. Use a 250 VDC megger for 230/240V input Drives and a 500VDC Megger for 480V input Drives.
2. Perform the test only on the main circuit as shown in Figure 7-1 when conducting a megger test on the Drive itself.
 - Do not conduct a megger test on the control circuits.
 - Short L1, L2, L3, U, V, W, P1, P(+), and DB, then megger to the Drive ground terminal E(G).
3. Use a high resistance range type tester to conduct a continuity test on the control circuits and not a megger or a buzzer.

PERIODIC PARTS REPLACEMENT

The life of the Drive will vary according to the installation environment and the amount of running time. However, if continuous operation is within the allowable limits, the life of the DC Link capacitor is approximately five years and the life of the cooling fan is approximately three years. It is recommended that these parts be replaced before failure occurs.

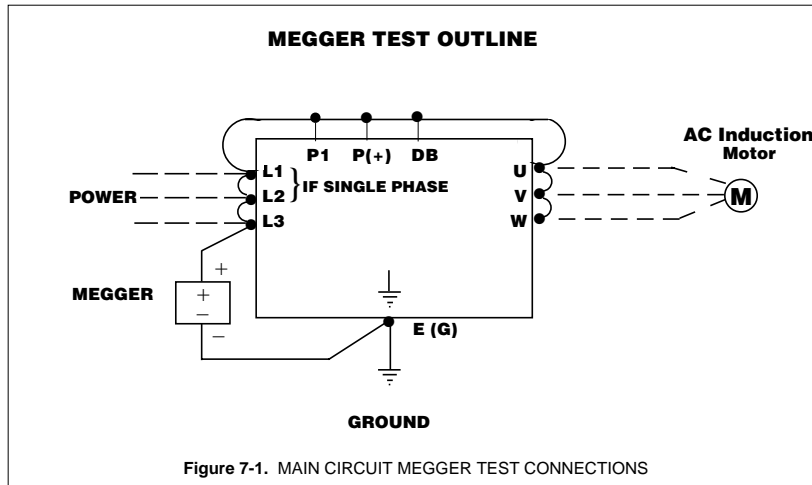

INSPECTION ITEMS

Refer to the Inspection Items Chart in this section for inspection points and corrective action.

INSPECTION ITEMS CHART		
Item	Inspection Criteria	Corrective Action
Power Supply Voltage	Within permissible limits (170-264 Vac) for 1 Phase 240 VAC Drives; (170-253) for 3 Phase 230 VAC Drives; and (323-528) for 3 Phase 480 Vac Drives.	Adjust the power supply voltage.
Ambient Temperature	Within permissible limits (-10° to +50° C) (+14° to +122°F.)	Investigate cause and make corrections until environment is within permissible limits.
Ambient Humidity	Within permissible limits (20 - 95% RH) No dew condensation or freezing.	Investigate cause and make corrections until environment is within permissible limits.
Vibration	Within permissible limit (0.6G or less) until within permissible limits.	Investigate cause and make adjustments.
Noise	Abnormal audio noise from cooling fan, etc.	Contact the supplier where the Drive was purchased.
Odor	Smell or burning.	Contact the supplier where the Drive was purchased.
Dust	Dust accumulation on cooling fins, cooling fan, or on the control board.	Clean and blow out with dry and filtered compressed air.
Screws/Connectors	Check for any loosening.	Re-tighten as needed.

MEASUREMENT POINTS AND METERS

Since the Drive's input/output voltage and current contain high frequencies, selection of the wrong measuring device can lead to gross miscalculations. When using a CT (current-detection transformer) to measure the current, the amount of error will be large if the frequency is low. Because of this, always use a CT with as large a capacity as possible. See the following chart and Figure 7-2 for recommended measurement devices.

RECOMMENDED MEASUREMENT DEVICE CHART

Item	Simple Measurement	Precision Measurement
Input Voltage	Tester - (Voltmeter)	Moving-Iron type voltmeter
Input Current	Clamp Meter	Moving-Iron type ammeter
Input Power	—	Electrodynamometer type wattmeter
Output Voltage	Tester - (Voltmeter)	Rectifier type voltmeter
Output Current	Clamp Meter	Moving-Iron type ammeter
Output Power	—	Electrodynamometer type wattmeter

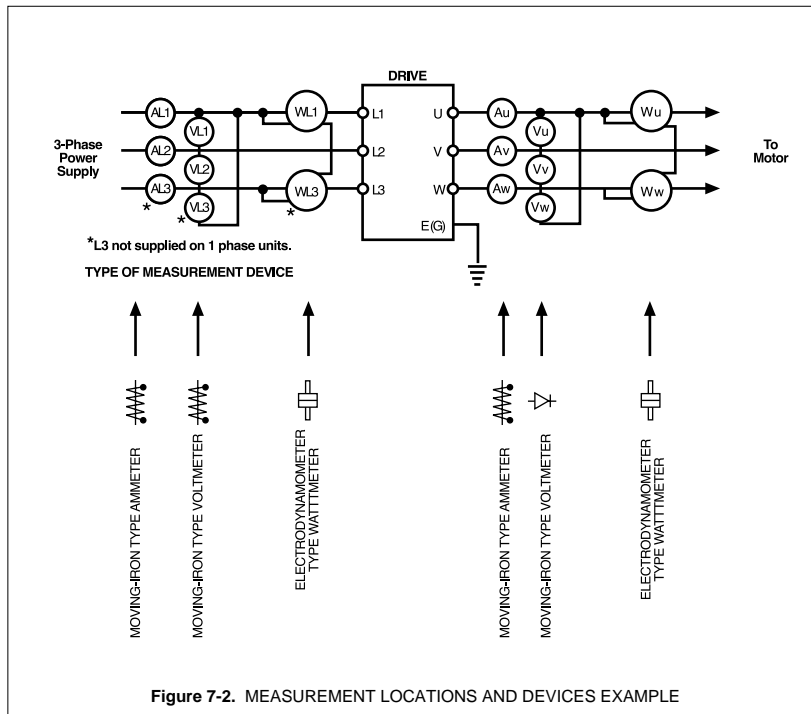

Figure 7-2. MEASUREMENT LOCATIONS AND DEVICES EXAMPLE

Section 8 TROUBLESHOOTING

TABLE 8: Fault Condition Description and Operation

The following Drive protection functions have been incorporated in the basic Drive software and will be indicated in the LED display. Use F_29 to check fault history.

Display	Protective Function	Function Explanation	LED Display	Protective Operation	
OC1, OC2, OC3	Overcurrent protection Short circuit, Ground fault	Protects the Drive if the Drive output current momentarily exceeds the overcurrent detection level. Protects the Drive from overcurrent resulting from an output phase-to-phase or phase-to-ground short circuit.	During Acceleration	OC1	<ul style="list-style-type: none"> • Drive output frequency drops to 0.0 Hz • Motor coasts to a stop • Alarm terminals 30A, 30B, and 30C are activated • Alarm signal is maintained internally until alarm reset command is given¹⁾
			During Deceleration	OC2	
LU	Momentary power failure Undervoltage protection	Avoids loss of control of the Drive caused by drops in the power supply. NOTE: Operation will continue if the momentary power failure or undervoltage period is less than 15 msec.	During Acceleration	LU	<ul style="list-style-type: none"> • Drive output frequency drops to 0.0 Hz if the "restart after momentary power failure" mode is selected, operation will restart automatically when power is restored.
			During Deceleration	OC3	
OU1, OU2, OU3	Overvoltage protection	Protects the Drive if momentary overvoltage (regenerative overvoltage) exceeds the overvoltage detection level.	During Acceleration	OU1	<ul style="list-style-type: none"> • Drive output frequency drops to 0.0 Hz • Motor coasts to a stop • Alarm terminals 30A, 30B, and 30C are activated • Alarm signal is maintained internally until alarm reset command is given¹⁾
			During Deceleration	OU2	
			During constant speed operation	OU3	
OH1, OH2,	Drive overheating External alarm input	Detects overheating of the Drive caused by an overload, cooling fan problem or abnormal ambient temperature. Acts as an external alarm to stop output. If protective device such as the overload relay is connected between THR and CM terminals switches from ON to OFF.	OH1	<ul style="list-style-type: none"> • Drive output frequency drops to 0.0 Hz. • Motor coasts to a stop • Alarm terminals 30A, 30B, and 30C are activated • Alarm signal is maintained internally until alarm reset command is given¹⁾ 	
			OH2		
OL OLU	Electronic overload	Protects semiconductor devices such as the IGBT from overloads. Protects a standard 4-pole motor or a forced air cooled motor from overloads even if an overload relay is not connected.	OLU	<ul style="list-style-type: none"> • Drive output frequency drops to 0.0 Hz. • Motor coasts to a stop • Alarm terminals 30A, 30B, and 30C are activated • Alarm signal is maintained internally until alarm reset command is given¹⁾ 	
			OL		
Er1, Er2, Er3, Er4, Er5, Er6, Er7	Memory Error	Operates when a memory error occurs due to a data writing error.	Er1	<ul style="list-style-type: none"> • Drive output frequency drops to 0.0 Hz. • Motor coasts to a stop • Alarm terminals 30A, 30B, and 30C are activated • Alarm signal is maintained internally until alarm reset command is given¹⁾ 	
	Communication Error ²⁾	Displayed when a communication error occurs between the Drive and the keypad panel.	Er2		
	CPU error	Stops the Drive when an error is detected in the CPU.	Er3		
	Optional circuit board communication error	Displayed when there is a communication "checksum error" or interruption of communication between the Drive and the option circuit board.	Er4		
	Option problem	Displayed when a link error etc. is detected.	Er5		
	Operating Proc. error	Detects Drive operating procedure error during Drive startup. FWD or REV connected to terminal CM at time of main power being applied to Drive. Stop keypad in remote operation	Er6		
	Output wiring error	Stops the Drive when it is detected that the output wiring is not connected during automatic tuning.	Er7		
NOTE 1	Alarm signal hold When a protection function has been activated and the alarm signal is output; if an AC contactor provided on the power supply side is switched off, and the Drive's control power is not supplied, the alarm signal will not be retained.				
NOTE 2	During external terminal operation (F02=1), the Drive will continue running without an alarm being tripped even if error Er2 is displayed. If communication is restored, the Er2 display will disappear, and normal operation will resume.				

TROUBLESHOOTING

If the function of the Drive is lost by a failure or if an abnormal condition has occurred, refer to the following diagnosis for its probable cause.

If the cause does not fall under the following explanation, or if the Drive is damaged, please contact GE Fuji Technical Services for assistance.

(1) Overcurrent

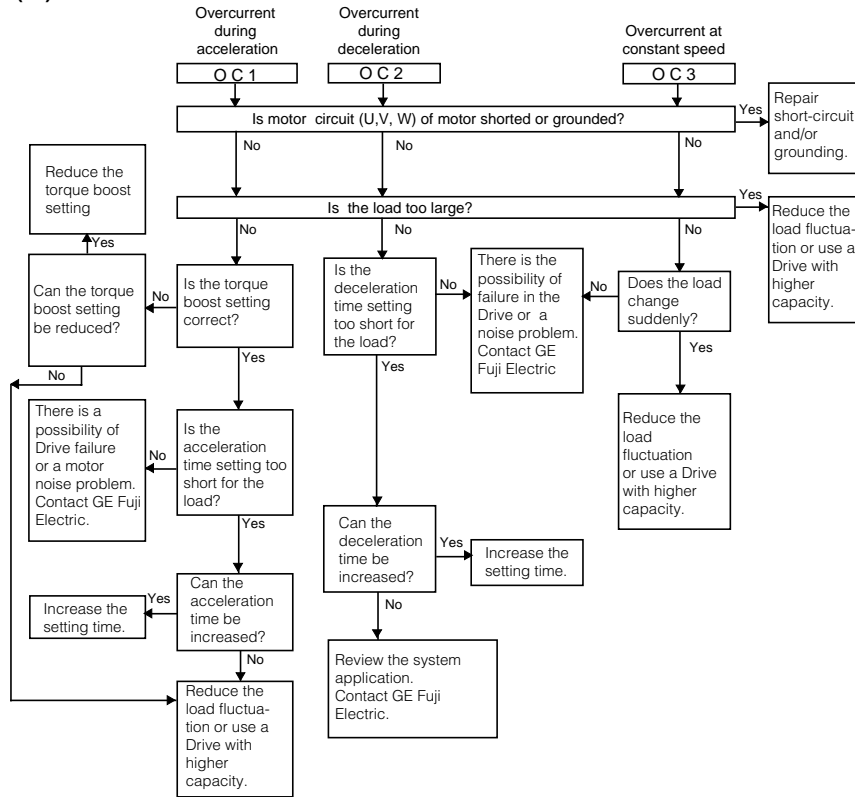

(2) Overvoltage

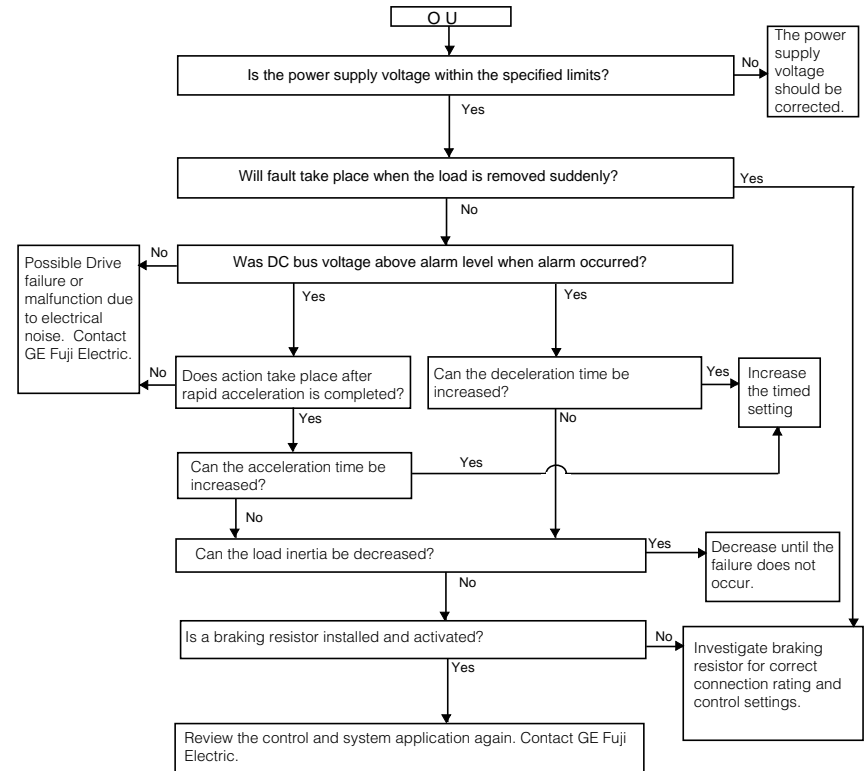

(3) Undervoltage

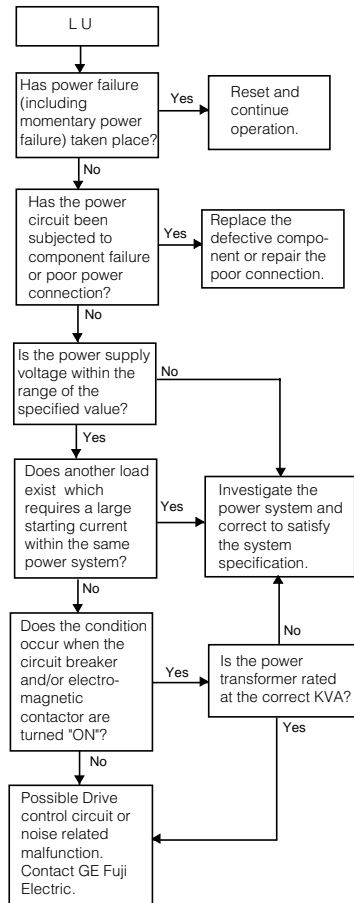

NOTE 1 – When the DC bus capacitor is discharged by a system power failure and the control power of the Drive is reduced, automatic restart after momentary power outage may take place. (Refer to Functon Code 14 setting.)

(4) Drive overheated

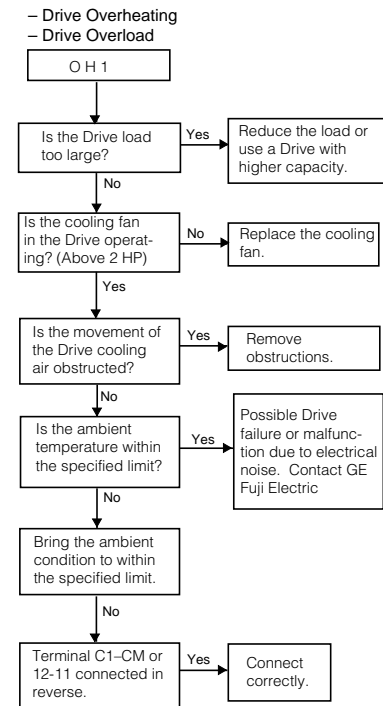

(5) External alarm input

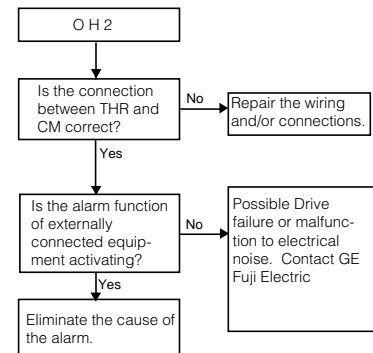

(6) Overload

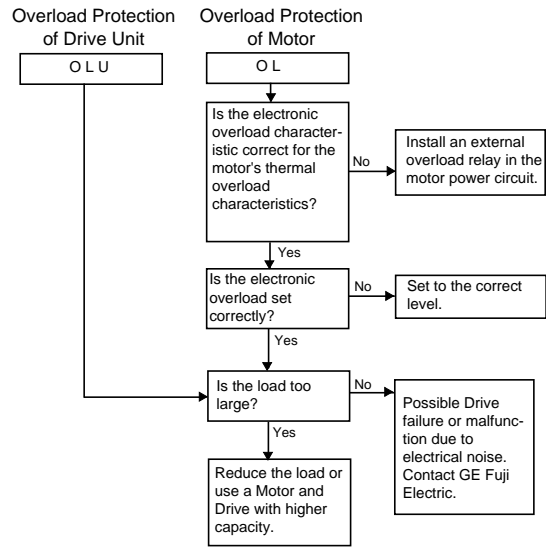

(7) Memory error, keypad communications error, CPU error

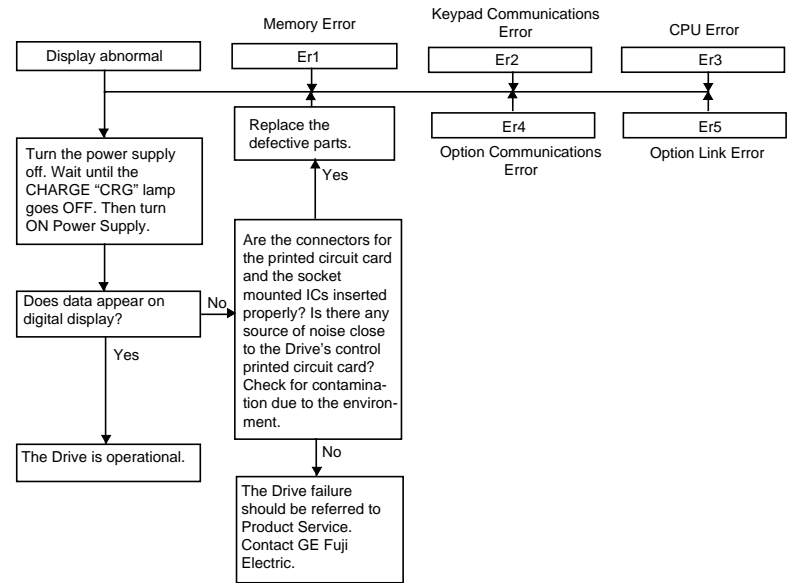

(8) Drive output circuit error

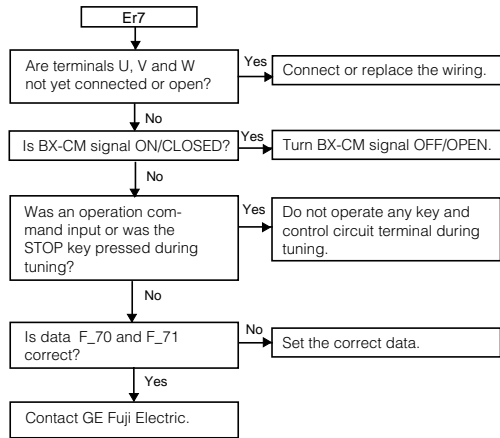

(9) Motor will not run.

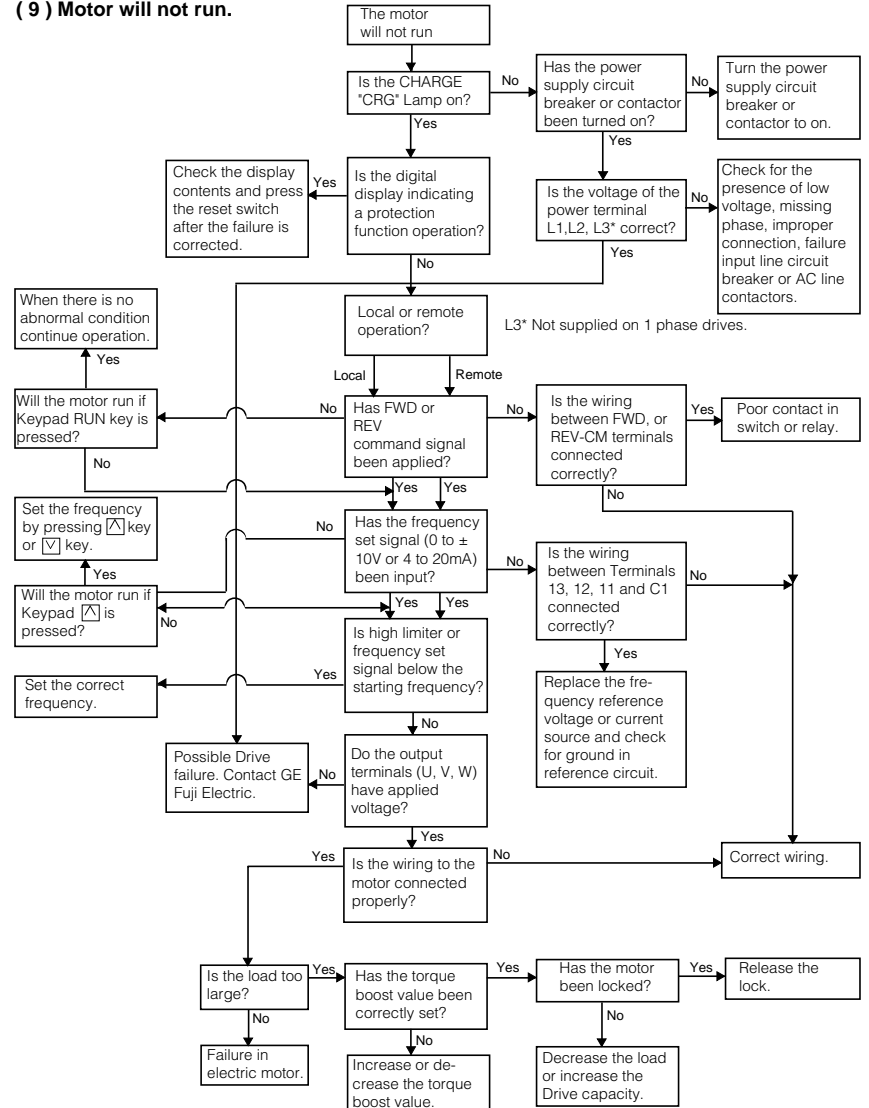

Motor will not run under these conditions:

- ① BX coast to stop command ON/CLOSED.
- ② Wrong setting at one of F_71, 72, 73, 75, or 76. When F_08 torque boost setting is 00 or F_69 torque vector control is active while using the wrong capacity motor (F_70, 75, 76.)

(10) Motor will run but speed will not change.

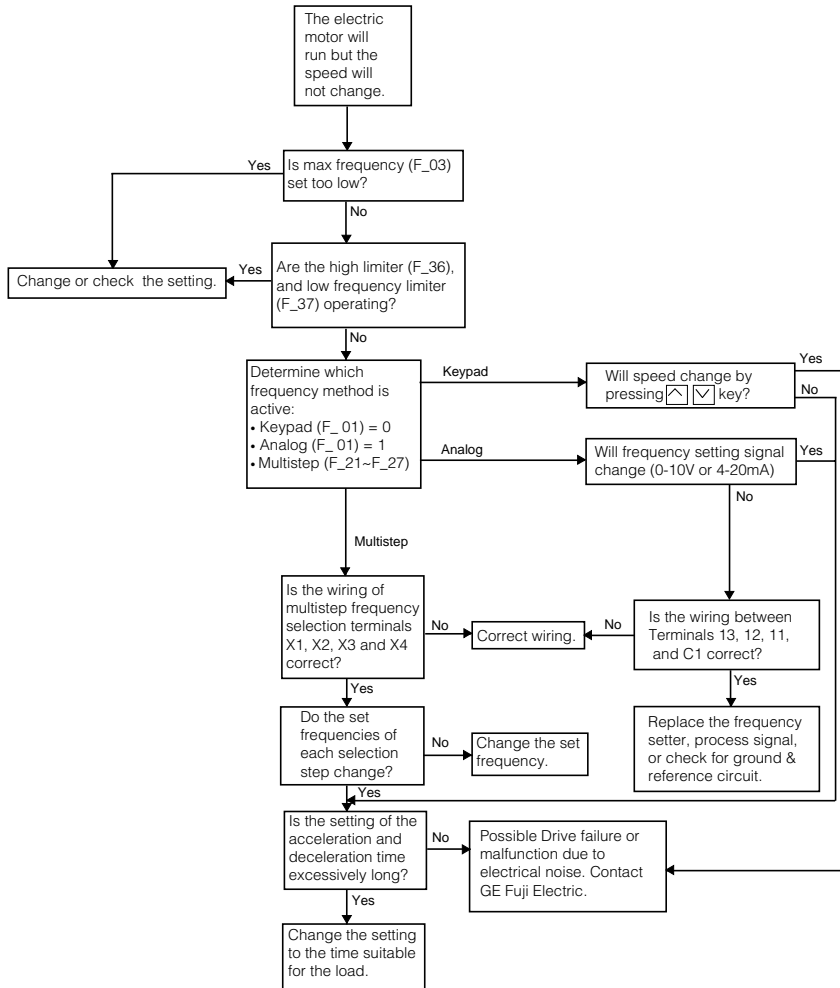

Motor speed change is very small under these conditions:

- ① Wrong setting of F_34 bias frequency, F_35 gain for frequency setting.
- ② If using terminal 12, and C1 check polarity inputs to insure they are correct and do not offset.
- ③ During torque limiting or current limiting with excessive load.

(11) Motor will stall during acceleration.

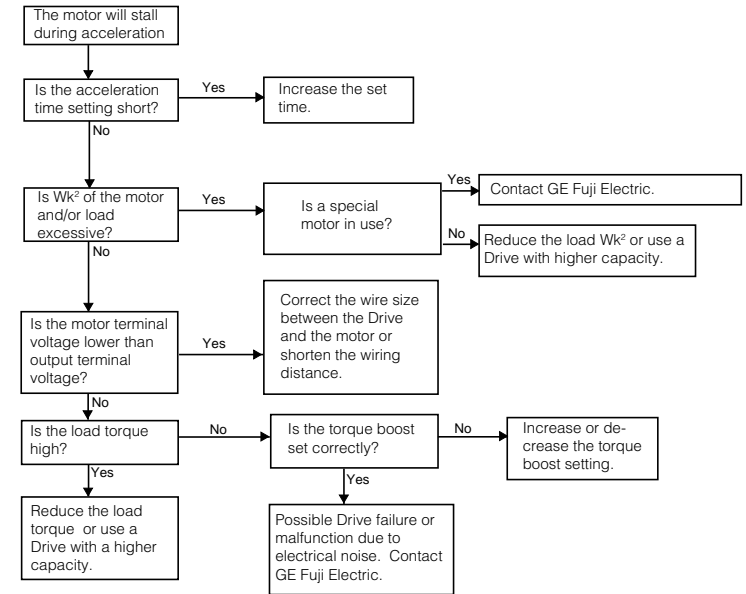

(12) Motor heating abnormal.

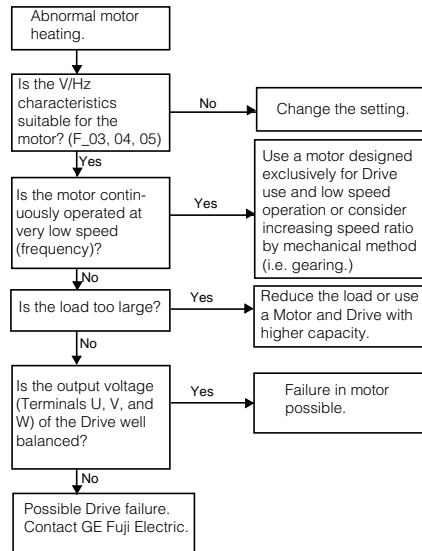

Section 9

WARRANTY PARTS AND SERVICE

The purpose of the following section is to provide specific instructions to the user of the AF-300 Micro-Saver II Drive regarding warranty administration and how to obtain assistance on both in-warranty and out-of-warranty equipment.

For all troubleshooting procedures, refer to Section 8 of this Instruction Book. To identify the part or assembly use the noted troubleshooting procedures in Section 8 and the information on page 9-2.

If assistance is required to either determine warranty status or identify defective parts call:

GE Fuji Drives USA, Inc.
1501 Roanoke Blvd. Suite 435
Salem, VA 24153
1-540-387-5739

WARRANTY COVERAGE

The Warranty set forth in Section 1 of FN-1090 (1/91) of GE's Condition of Sale covers all major parts of the Drive such as the main printed circuit boards, transistor modules, etc. The warranty covers replacement of the entire Drive.

"Warranty period is 12 months after installation or 18 months after shipment from the Company, whichever occurs first."

Before calling the number at left to determine warranty status, the Drive serial number will be required. This is located on the Drive nameplate. If the Drive is still under warranty, further information will be required per the "In-Warranty Failure Checklist" shown on page 9-2 of this Instruction Book.

OUT-OF-WARRANTY PROCEDURES

When the defective part has been identified, contact your local Authorized AF-300 Micro-Saver II Distributor to order replacement parts.

MOTORS

Repairs on motors are generally handled by the motor manufacturer. For specific instructions on your motor, call the distributor from which it was purchased and be prepared to furnish complete nameplate data.

IN-WARRANTY FAILURE CHECKLIST

To assist with warranty troubleshooting, the following information is required. This data is needed to evaluate the cause in an effort to eliminate any further failures.

Model No.: _____

Serial No.: _____

Start-Up Date: _____

Failure Date: _____

Status When Failure Occurred (check one):

Power-Up _____ Running _____ Accel _____ Decel _____

Explanation of Failure: _____

Application Information (check Yes or No)

Input Transformer: Yes _____ No _____

If Yes: KVA _____

L1 Volts _____ L2 Volts _____ L3 Volts _____

Power Factor Correction Capacitors: Yes _____ No _____

If Yes: Microfarad _____

Other Equipment on Same Power Yes _____ No _____

If Yes, what?

Line Reactor on Input Yes _____ No _____

Input Starter Yes _____ No _____

Output Starter Yes _____ No _____

Motor Overloads Yes _____ No _____

Control Terminals Used (circle if used)

THR X1 X2 X3 30A 30B 30C

RST/BX FWD REV C1 11 12 13

RUN RT1

Function Codes Different From Factory Settings

Function Code	Setting	Function Code	Setting

Failure Message (see Section 5)

Latest Fault _____ **Previous Faults:** _____ **No Message** _____

Hz _____ 1. _____

A _____ 2. _____

V _____ 3. _____

After all of the Checklist information is acquired, contact the following Service Center number for assistance:
540-387-5739 (8am - 5pm Central Standard time Monday thru Friday).
540-387-8292 (24-hour emergency)

When you return the unit or parts for warranty you need to get a RMA number from your Service Center.

AF-300 Micro-Saver II Spare Parts List

Description	Part No.	6KMS223***N1A1(X4A1)					6KMS221***N1A1(X4A1)					6KMS243***N1A1(X4A1)						
		F25	F50	001	002	003	005	F25	F50	001	002	003	F50	001	002	003	005	
Control PCB	E9-CPCBF25-MS2	1																
	E9-CPCBF50-MS2		1															
	E9-CPCB001-MS2			1														
	E9-CPCB002-MS2				1													
	E9-CPCB003-MS2					1												
	E9-CPCB005-MS2						1											
	E9-CPCBF25-MS7							1										
	E9-CPCBF50-MS7								1									
	E9-CPCB001-MS7									1								
	E9-CPCB002-MS7										1							
Terminal PCB	E9-TPCB-SW	1	1	1	1	1	1	1	1	1	1	1	1	1	1	1	1	
	Capacitor Unit	E9-CU2-0.2	1															
		E9-CU2-0.4		1														
		E9-CU2-0.8			1					1		1						
		E9-CU2-1.5				1												
		E9-CU2-2.2					1											
E9-CU2-3.7							1											
Fan	E9-CU7-0.4							1	1									
	E9-CU7-1.5									1								
	E9-CU7-2.2										1							
	E9-CU4-0.4											1						
	E9-CU4-0.8												1					
	E9-CU4-1.5													1				
Power Module	E9-CU4-2.2														1			
	E9-CU4-3.7															1		
Fan	E9-FAN1.5				1		1	1							1	1	1	
	E9-FAN3.7					1	1											
	Power Module	4613-02-2	1															
		4624-04-2		1														
		4634-08-2			1													
		4704-15-2				1												
		4714-22-2					1											
		4724-37-2						1										
	4655-02-7							1										
	4665-04-7								1									
4675-08-7									1									
4735-15-7										1								
4745-22-7											1							
Power Module	8406-04-4											1						
	8416-08-4												1					
	8426-15-4													1				
	8436-22-4														1			
8446-37-4																1		

Section 10 CE MARK

Electromagnetic Compatibility (EMC)

General

In accordance with the provisions described in the European Commission Guidelines Document on Council Directive 89/336/EEC, GE Fuji Electric Co., Ltd. has chosen to classify the 1 phase, 240 VAC, 3 phase 415 VAC range of Drives as "Complex Components". Classification as "Complex Components" allows a product to be treated as an "apparatus", and thus permits compliance with the essential requirements of the EMC Directive to be demonstrated to both an integrator of Micro-Saver II Drive and to his consumer or the installer and user.

Micro-Saver II Drives up to 5 Hp are supplied 'EC - marked', signifying compliance with EC Directive 89/336/EEC when fitted with specified filter units installed and earthed in accordance with this sheet. This specification requires the following performance criteria to be met.

Immunity : EN50082 - 2
Emissions : EN50081 - 1

RFI Filters

It is strongly recommended that the appropriate Micro-Saver II Drive input filter be used to limit RF current flowing into the main supply circuit. (Refer to Table 10-1.) Without an input filter a Micro-Saver II Drive installation may not meet statutory requirement. Micro-Saver II Drive contain high - power semi - conductor devices which are switched at high speeds to synthesize a near - sinusoidal current waveform across the frequency range of output. Rapidly changing voltages and currents will generate some degree of electromagnetic emission.

Emissions will be predominantly conducted through the motor and the main supply cables, although some radiated emissions will be detected in close proximity to the drive system. It is essential that precautions are taken at the design stage, and at the time of installation, to prevent radio frequency interference. (RFI) from the drive system affecting sensitive equipment in close proximity.

The RFI filters range are designed especially for the Micro-Saver II Drive and help to ensure EMC compliance of machinery as installations using Inverters. The Drives may be mounted on top of the filter using integral fixing positions, the intention being that valuable space inside wiring cabinets may be saved. (Refer to Fig. 10 - 1 and Table 10- 1)

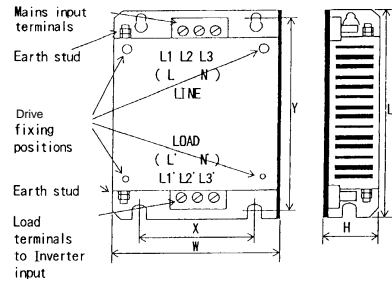

Fig. 10-1 RFI Filters

Filter Part No.	Applied Drive	Rated Current	Max Rated Voltage	Dimensions L,W,D mm	Mount Dim. X, Y	Inverter Fixings	Required Sub Filter
AFL-0.2 E9-7	6KMS221F25N1A1 6KMS221F25X4A1	3A	1 Phase 240 VAC	200x110x34	84x186	M4x12(4)	Ferrite Ring OC1x1pcs
EFL-0.75 E9-7	6KMS221F50N1A1 6KMS221F50X4A1 6KMS221001N1A1 6KMS221001X4A1	10A					Ferrite Ring OC1x1pcs
EFL-2.2 E9-7	6KMS221002N1A1 6KMS221002X4A1 6KMS221003N1A1 6KMS221003X4A1	23A	3 phase 415 VAC	200x205x40	178x186	M4x12(4)	Ferrite Ring OC1x1pcs
EFL-0.75 E9-4	6KMS243F50N1A1 6KMS243F50X4A1 6KMS243001N1A1 6KMS243001X4A1	3A					Ferrite Ring OC1x1pcs
EFL-4.0 E9-4	6KMS243002N1A1 6KMS243002X4A1 6KMS243003N1A1 6KMS243003X4A1 6KMS243005N1A1 6KMS243005X4A1	12A					Ferrite Ring OC1x1pcs

Table 10-1 RFI Filters Dimensions - Conforms to EN55011 Class B

Recommended Installation Instructions

These instructions must be followed in order to conform to the EMC Directive. Follow the usual safety procedures when working with electrical equipment. All electrical connections to the filter, Inverter, and motor must be made by a qualified electrical technician. (Refer to Fig.2, Fig. 3, and Fig.4)

1. Check the filter rating label to ensure that the current, voltage rating, and part number are correct.
2. The back panel of the wiring cabinet board should be prepared for the mounting dimensions of the filter. Care should be taken to remove any paint etc. from the mounting holes and face area around the hole of the panel. This will ensure the best possible earthing of the filter.
3. The filter should be securely mounted in position, and the Inverter mounted to the front of the filter with the screws provided.
4. Connect the incoming main supply to the filter terminals marked "LINE" and any earth cables to the earth stud provided. Fit the Input Ferrite Ring

- (if two ferrite rings are required, refer to table 1), and connect the filter terminals marked "LOAD" to the main input of the of the Drive using a short length of appropriate gauge wire.
5. Fit the output Ferrite Ring as close to the Inverter as possible and connect the motor. Armored or screened cable should be used with the 3 phase conductors passing twice through the center of the Output Ferrite Ring. The earth conductor should be securely earthed at both the ground terminal in the cabinet and at the motor ends. The screen should be connected to the enclosure.
6. It is important that all lead lengths are kept as short as possible and that incoming mains and outgoing motor cables are kept well separated.
7. Segregate power cables from control wiring, as thoroughly as possible, and avoid parallel cable run to minimize 'noise coupling'. When ever runs of power and control cable must cross, try to achieve this at right angles.
8. Micro-Saver II Drive should be installed, and are designed to operate, with an electrically - shielded metal enclosure.

Basic Standard : EN55011 Class B

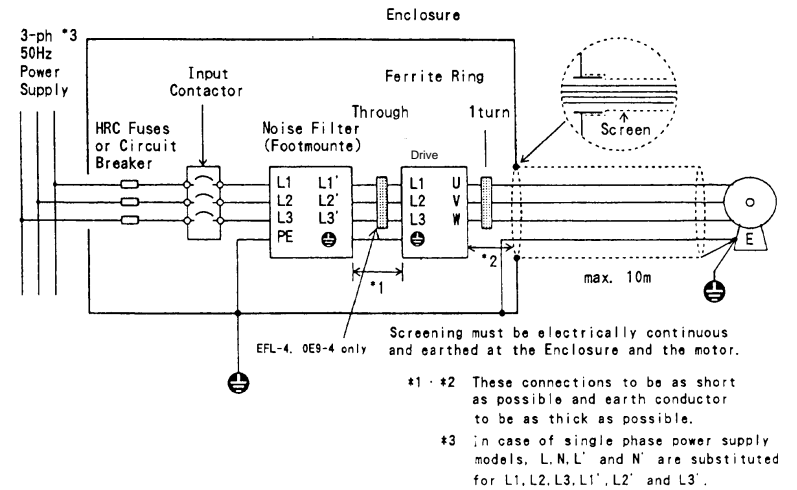

Fig. 10-2 Recommended installation

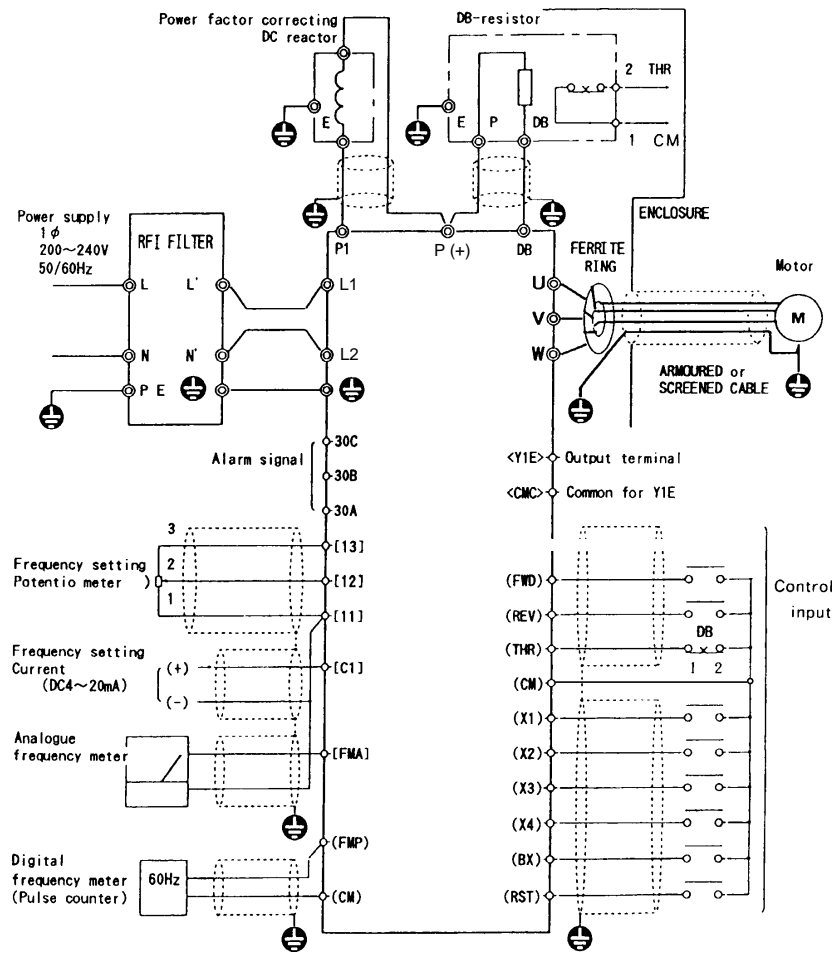
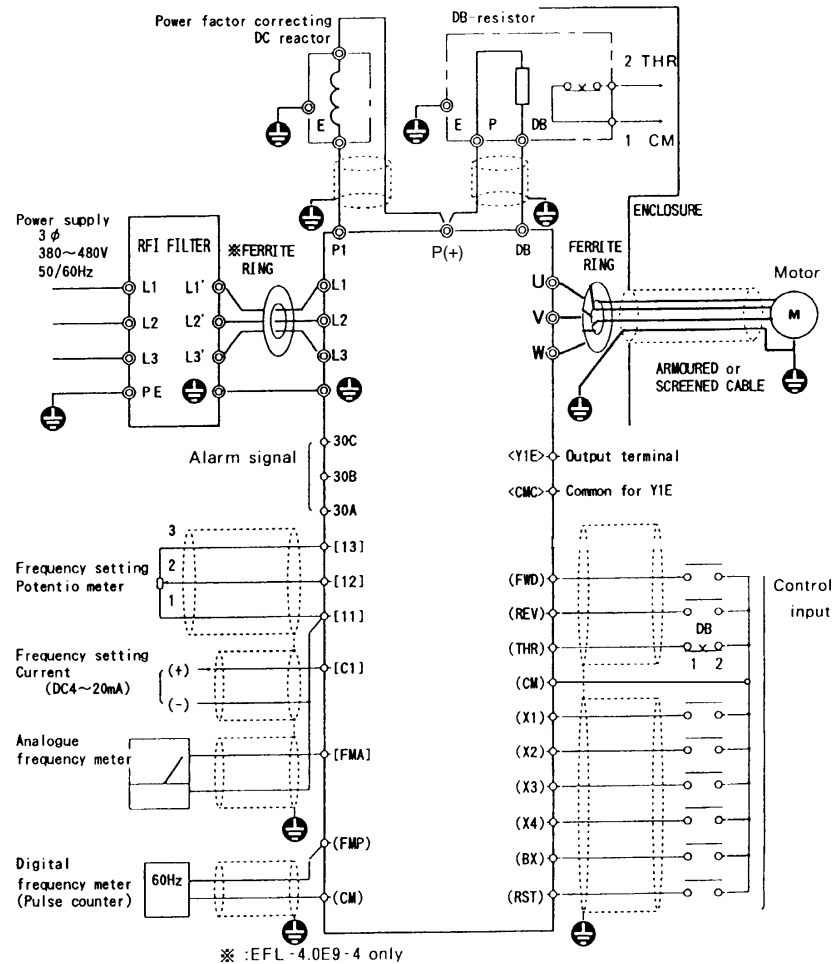

Fig. 10-3 Recommended installation detail inside the enclosure (1)



※ :EFL-4.0E9-4 only

Fig. 10-4 Recommended installation detail inside the enclosure (2)

EC Declaration of Conformity

Product identification

Product: Inverter
Brand: GE Fuji Electric
Model/type: 6KMS\$221F25N1A1 to 6KMS\$221003N1A1
6KMS\$221F25X4A1 to 6KMS\$221003X4A1
6KMS\$243F50N1A1 to 6KMS\$243005N1A1
6KMS\$243F50X4A1 to 6KMS\$243005X4A1

to which this Declaration relates is in conformity with the EMC requirements of the following standards.

Immunity: EN50082-2 "Generic immunity standard Part 2 (industrial environment)"
Emission: EN50081-1 "Generic emission standard Part 1 (Residential, commercial and light industrial)"

and conforms to the protection requirements of Council Directive: 89/336/EEC

relating to Electromagnetic Compatibility

When: Wired and earthed in accordance with the installation instructions.
Installed in a steel enclosure.
Used in conjunction with power input filter and ferrite rings which are recommended by
GE Fuji Electric.

Product identification

Product:: Inverter
Brand: GE Fuji Electric
Model/Type: 6KMS\$221F25N1A1 to 6KMS\$221003N1A1
6KMS\$221F25X4A1 to 6KMS\$221003X4A1
6KMS\$243F50N1A1 to 6KMS\$243005N1A1
6KMS\$243F50X4A1 to 6KMS\$243005X4A1

to which this Declaration relates is in conformity with the Low Voltage requirements of the following
standard(s):

DIN VDE0160/1988

Category : Overvoltage category II/Pollution degree 2
and conforms to the protection requirements of Council Directive: 73/23/EEC

relating to low voltage

When: Wired and earthed in accordance with the installation instructions.
Installed in a steel enclosure satisfied 'Pollution degree 2'.
Used in conjunction with 3AC power supply (Line) which has an earthed neutral-point for 3 phase
Input Drive and used in conjunction with 1AC power supply (Line) whose one line is earthed for
1-phase Input Drive.



GE Fuji Drives USA, Inc.
1501 Roanoke Blvd. Suite 435
Salem, VA 24153

1-800-543-6196
Internet Address: <http://www.ge.com>